

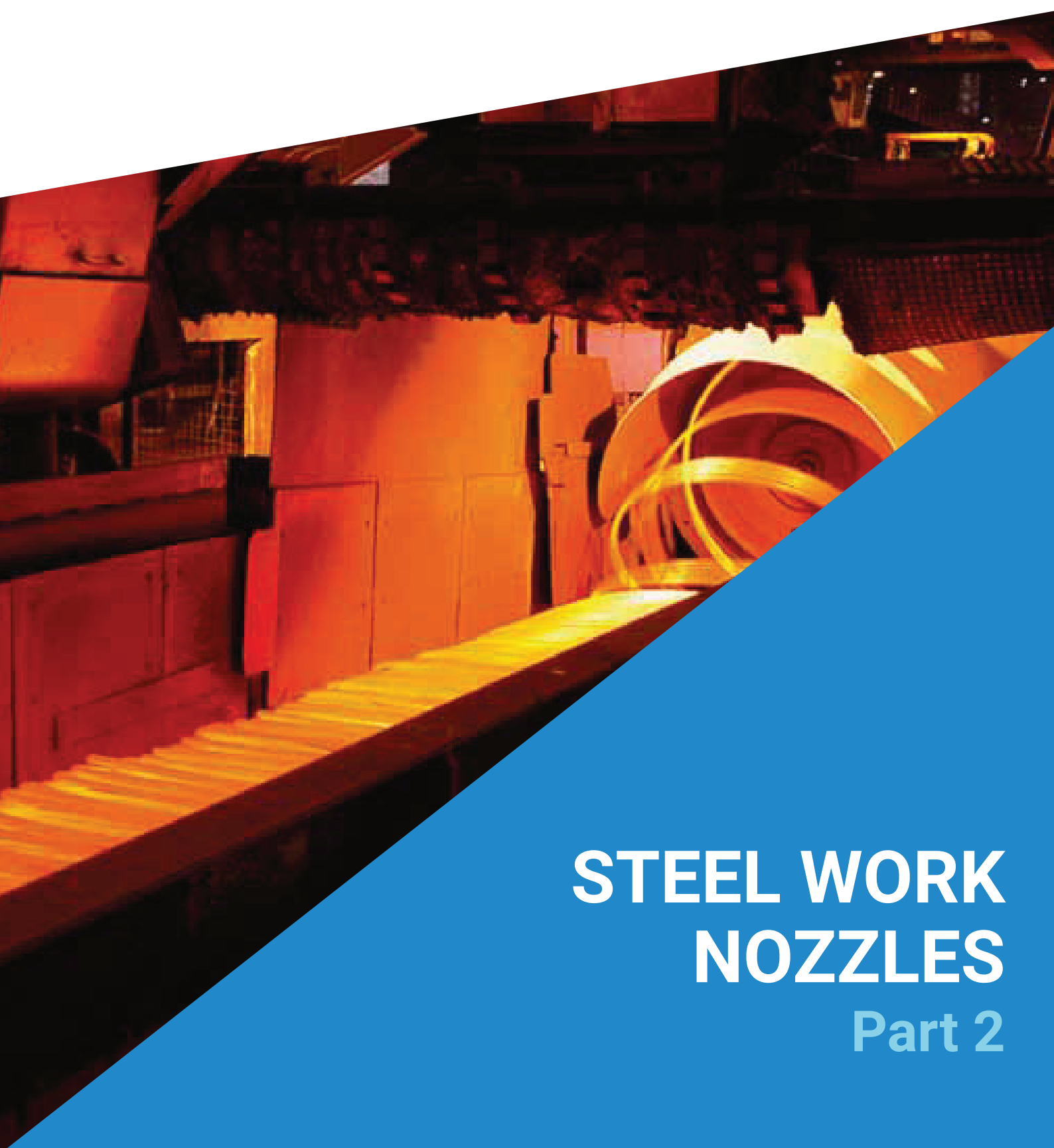

# SPRAY NOZZLES FOR INDUSTRIAL APPLICATIONS



## STEEL WORK NOZZLES Part 2



## **PNR ITALIA**

**PNR ITALIA**, with over 40 years experience, is a world wide leader in spray technology offering general and specialized products for all industrial sectors.

Resulting from our years of success, **PNR** offers a complete range of product directed at the Steel Works Industry. From Continuous Casting, Hot Rolling, Pickling, **PNR** has the products for Dust Suppression, Primary/Secondary Cooling, Pollution Control, Steel Cutting and complete Water Treatment Filtration. (this follows the Index pages 6-7)

**PNR** support surpasses others and starts at our Corporate Headquarters in Voghera, Italy with manufacturing, technical department, up to date computer software, ISO Certified (the ISO cert could be located on the bottom of this page as well), and laboratory (open to customer visits).

You are also personally supported by **PNR's** commercial branches in many countries in Europe, Asia and North America, as well as, our many distributors world wide.

We encourage you to visit [www.pnr.eu](http://www.pnr.eu) to learn more about how **PNR** is your correct choice for Industrial Spray Nozzles.

*All PNR catalogues are available for download:*

<b>CTG SW</b>	Steelworks nozzles
<b>CTG UG</b>	Spray systems for industrial applications
<b>CTG LS</b>	Tank washing systems
<b>CTG AZ</b>	Air-assisted atomizers
<b>CTG LN</b>	Cooling lances
<b>CTG SP</b>	Spray drying nozzles
<b>CTG PM</b>	Paper mill nozzles
<b>CTG AC</b>	Assembly parts and complementary products
<b>CTG KL</b>	Cleaning and washing technologies
<b>CTG FF</b>	Fire-fighting products and systems

*Our products are constantly reviewed and adapted to the current most modern technical level. Therefore our documentation is updated accordingly and sent to customers registered on our mailing list. To be included in this list you can send us your request with your exact e-mail or physical address.*

# PRODUCT IDENTIFICATION

## PNR CODING SYSTEM

Every industrial product needs to be identified with a code to avoid mistakes.

PNR product coding system was conceived to meet the following requirements:

- codes are easily listed by a computer in alphabetical order.
- codes fully describe the product, with no need of further information.
- codes immediately provide the main characteristics of each product so to find it in the catalogue easily.

Code Definition is as follows:

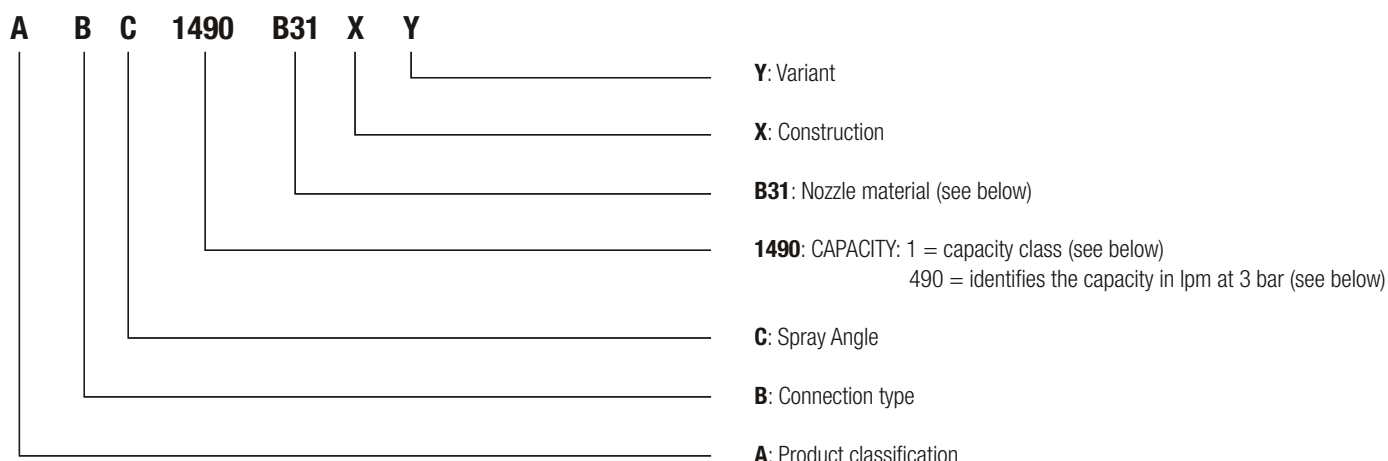

Flow rate capacity at 3 bars.

These codes are purely indicative, their meaning may be occasionally different. Please always refer to the numeric indication of the angles beside each table.

### CAPACITY CLASS

Class	Numbers	Capacity in lpm
0	0 490	0,49
1	1 490	4,90
2	2 490	49,0
3	3 490	490
4	4 490	4900

### COMMON SPRAY ANGLES

<b>A</b> = 0°	<b>L</b> = 40°	<b>T</b> = 80°
<b>B</b> = 15°	<b>M</b> = 45°	<b>U</b> = 90°
<b>C</b> = 20°	<b>N</b> = 50°	<b>J</b> = 110°
<b>D</b> = 25°	<b>Q</b> = 60°	<b>W</b> = 120°
<b>F</b> = 30°	<b>R</b> = 65°	<b>Y</b> = 130°
<b>H</b> = 35°	<b>S</b> = 75°	<b>Z</b> = 180°

### PNR PRODUCTS MATERIALS CODES

<b>A1</b>	Carbon steel
<b>A2</b>	High speed steel
<b>A8</b>	Zinc coated steel
<b>A9</b>	Nickel coated steel
<b>B1</b>	Stainless steel AISI 303
<b>B2</b>	Stainless steel AISI 304
<b>B21</b>	Stainless steel AISI 304L
<b>B3</b>	Stainless steel AISI 316
<b>B31</b>	Stainless steel AISI 316L
<b>C1</b>	Stainless steel AISI 420 hardened
<b>C2</b>	Stainless steel AISI 416, hardened
<b>D1</b>	Polyvinylchloride (PVC)
<b>D2</b>	Polypropylene (PP)
<b>D3</b>	Polyamide (PA)

<b>D5</b>	Talcum filled Polypropylene
<b>D6</b>	Glassfibre reinforced PP
<b>D7</b>	High density polyethylene
<b>D8</b>	Polyvinylidene fluoride (PVDF)
<b>E0</b>	EPDM
<b>E1</b>	Polytetrafluorethylene (PTFE)
<b>E2</b>	PTFE (25% glassfibers)
<b>E31</b>	Acetalic resin (POM)
<b>E7</b>	Viton
<b>E8</b>	Synthetic rubber (NBR)
<b>F1</b>	Tungsten carbide
<b>F5</b>	Ceramic
<b>F31</b>	Ruby insert, 303 body
<b>G1</b>	Cast iron

<b>H1</b>	Titanium
<b>L1</b>	Monel 400
<b>L2</b>	Incolloy 825
<b>L8</b>	Hastelloy C276
<b>P6</b>	Acr. But. Styrene (ABS)
<b>P8</b>	EPDM 40 Shore
<b>T1</b>	Brass
<b>T2</b>	Brass, chrome plated
<b>T3</b>	Copper
<b>T5</b>	Bronze
<b>T8</b>	Brass, nickel plated
<b>T81</b>	Brass, electroless nickel plated
<b>V1</b>	Aluminum
<b>V7</b>	Aluminum, electroless n. plated

**LIST OF ABBREVIATIONS - LEGENDA**

<b>AI</b>	Inlet air capacity	Nmc/min
<b>AO</b>	Outlet air capacity	Nmc/min
<b>CL</b>	Spray jet deflection angle	degrees
<b>D</b>	Nozzle orifice conventional diameter	mm
<b>D1</b>	Minimum internal passage diameter	mm
<b>DE</b>	Supply passage diameter	mm
<b>DF</b>	Flange size	inch
<b>DIA</b>	Outer diameter	mm
<b>DN</b>	Flange nominal size	mm
<b>DU</b>	Outlet orifice diameter	mm
<b>DX</b>	Nipple inside diameter	mm
<b>FF</b>	Flange outer diameter	mm
<b>G</b>	Flange holes centre to centre diameter	mm
<b>H, H1, H2</b>	Height	mm

<b>L, L1</b>	Length	mm
<b>LF</b>	Pipe length	m
<b>LP</b>	Maximum operating pressure	bar
<b>LQ</b>	Maximum capacity	lpm
<b>LT</b>	Maximum operating temperature	°C
<b>NR</b>	Number of orifices	-
<b>QC</b>	Quick coupling connection	-
<b>RA</b>	Range	mm
<b>RF</b>	Cylindrical female thread BSP	inch
<b>RG</b>	Conic male thread BSPT	inch
<b>S</b>	Thickness	mm
<b>SQ</b>	Square bar size	mm
<b>W</b>	Weight	gr, kg
<b>WS</b>	Hexagon key	mm

**PRODUCT WARRANTY**

PNR products will be replaced or repaired at the option of PNR and free of charges if found defective in manufacturing, labelling or packaging. The above warranty conditions will apply if notice of defect is received by PNR within 30 days from date of product installations or one year from date of shipment. The cost of above said replacement or repair shall be the exclusive remedy for any breach of any warranty, and PNR shall not be held liable for any damage due to personal injuries or commercial losses coming from product malfunction.

Our Company Procedure for warranty cases requires the following steps to be performed:

- 1 Contact our Quality manager and obtain from PNR a return authorization number
- 2 Return the products together with our Form 3DA A04 duly completed
- 3 PNR shall issue a test report, send you a copy and return the product repaired or replaced

Our Company scope is to offer full Customer satisfaction, and we are fully aware of the inconvenience which can be originated from a defective product. Please be assured we shall do our best to make available a perfect product in the shortest possible time.

**PRODUCT RETURN POLICY**

**PRODUCTS DELIVERED IN ERROR FROM PNR**

- 1 Obtain from PNR a return authorization number.
- 2 Return the products together with our Form 3DA A04 duly completed.
- 3 PNR shall issue a Credit Note for full Product and shipping costs.

**PRODUCTS ORDERED INCORRECTLY TO PNR**

- 1 Obtain from PNR a return authorization number.
- 2 Return the products at your expense together with the form 3DA A04 duly completed.
- 3 Products shall be returned in original condition, inside the original packaging
- 4 A re-stocking change of 15% applies.

**NON CATALOG PRODUCTS**

These products can only be returned after a written authorisation from PNR has been obtained.

**DISCLAIMER**

Our products are manufactured with the best care and according to the latest developments of the technology, but we cannot assure that every one of our products is perfectly fit for any possible specific process. The information in this Catalogue is provided "as is" and we make no warranty of any kind with respect to the subject matter or accuracy of the information contained herein. This publication may include technical inaccuracies or typographical errors and changes may be periodically made to the information herein without prior notice.

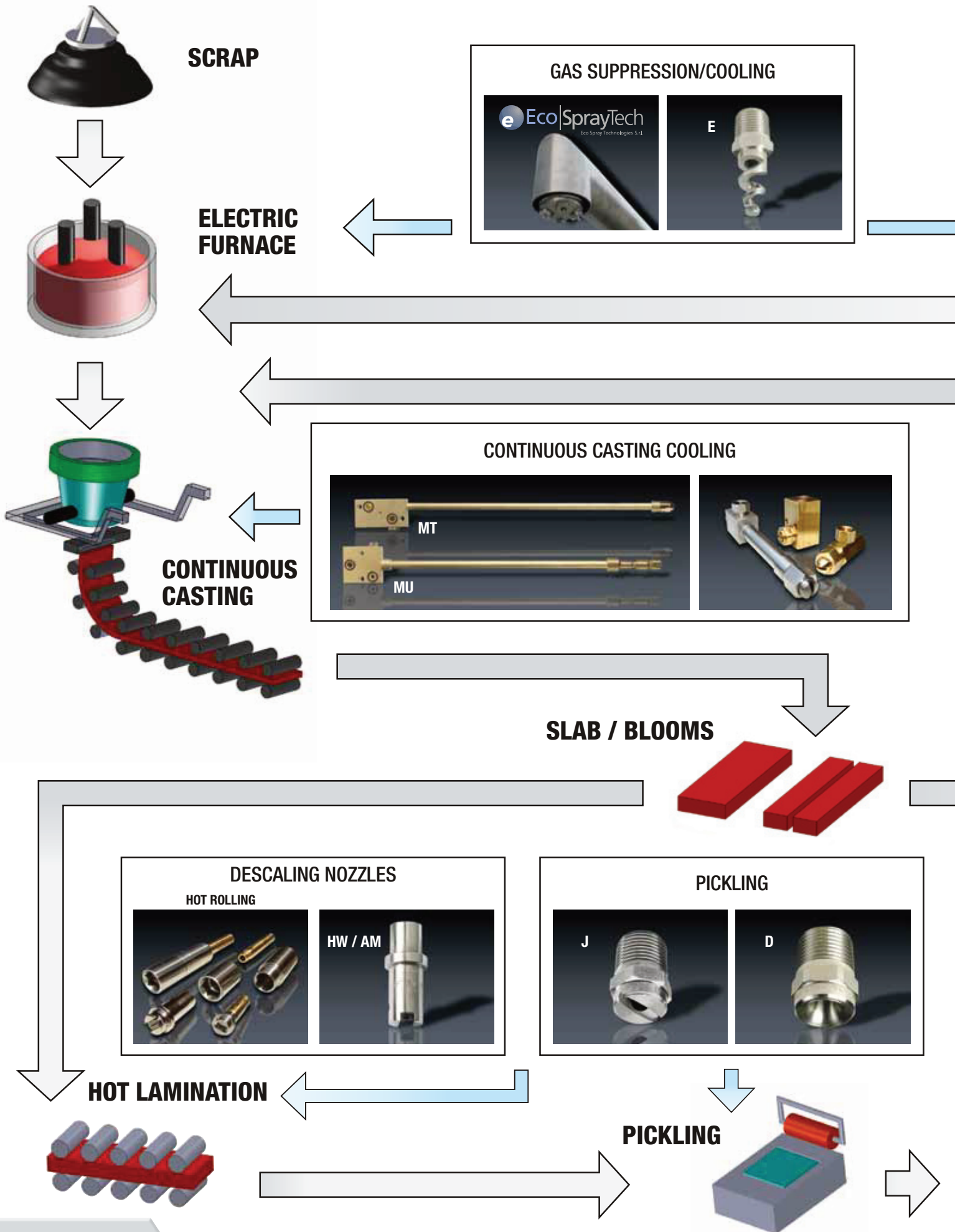

## DUST SUPPRESSION ON RAW MATERIALS PARK

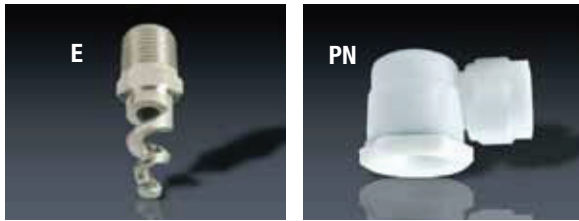

## RAW MATERIALS



## BASIC OXIGEN CONVERTER



## BLAST FURNACE

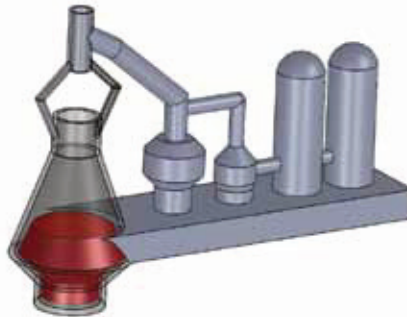

## COKE COOLING



## COLD LAMINATION

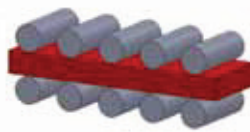

## COILS



## ROLLS COOLING



## COLD LAMINATION

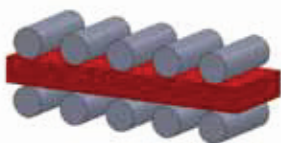

## ANNEALING



## TEMPER

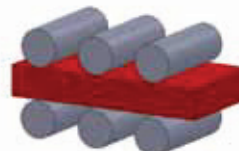

## COILS



	<b>Page</b>
<b>ISO 9001:2000 CERTIFICATION</b>	1
<b>PRODUCT IDENTIFICATION</b>	2
<b>GENERAL INFORMATION</b>	3
<b>NOZZLES IN STEELWORKS</b>	4
<b>DESCALING</b>	
- Descaling Principles - Descaling nozzles feature - Impact measurement	38
<hr/>	
- Model "GW" - Dove tail nozzle tips	40
Assembly parts GW	41
<hr/>	
- Model "HW/AH" - Short nozzles - Standard size	42
Assembly parts HW/AH	43
<hr/>	
- Model "HW/AA" - Nozzle tips, mini-sized	44
Assembly parts HW/AA	45
<hr/>	
- Model "HW/AK" - High impact nozzle tips, standard-sized	46
Assembly parts HW/AK	47
<hr/>	
- Model "HW/AB" - High impact nozzle tips, mini-sized	48
Assembly parts HW/AB	49
<hr/>	
- Model "HV/AH" - High impact nozzle tips, special-sized	50
Assembly parts HV/AH	51
<hr/>	
- Model "HW/AM" - High impact nozzle tips, micro-sized	52
Assembly parts HW/AM	53



	Page
<b>COLD ROLLING / PICKLING</b>	
- Model "J (H - USA MARKET)" - Flat fan jet nozzle	54
<b>ROLLS COOLING</b>	
- Model "KYA" - Rolls cooling nozzle	57
- Model "UEA D020" - Air knife cooling systems round jet	58
- Model "UEA L022" - Air knife cooling systems flat fan jet	59
- Model "UEB" - Air knife cooling systems bar blowers	60



We regret not being able to update our customers on the continuous improvements to our product range, so please consider the information and product specifications supplied in this catalogue as indicative and not binding for our company. For each application that requires one or more characteristics of one of our catalogue products that must be strictly maintained, please kindly ask for a written confirmation. Any information contained in this Catalogue, codes and product specifications, sketches, drawings and photographs, is the exclusive property of Flowtech Srl and it is forbidden to reproduce it in any medium without express written permission of the same.

All dimensions in this catalogue are in millimetres (mm). All threads to be manufactured according to ISO 228 unless otherwise specified. (European Standard BS 2779 - DIN 259 - UNI 338).

All trademarks mentioned in this catalogue are owned by their respective owners.



# DESCALING

## DESCALING PRINCIPLES

The descaling process is crucial in steel industry to obtain higher quality products. Descaling nozzles are used for an efficient scale removal in hot rolling. The best method is the hydro-mechanical descaling process using high pressure water jets formed by special descaling nozzles. Working pressure range is from 50 to 400 bar (725 to 5.800 psi), for GW type from 30 to 200 bar (435 to 2.900 psi). The impact of the water jet on the steel hot surface produces an impact force that, combined with the thermal action due to the temperature difference between jets and slabs, generates the descaling effect. The jet quality of the nozzle has a great effect upon the steel surface descaling in hot-rolling and is crucial for the quality of the final product.

## DESCALING NOZZLES FEATURE

An efficient scale removal requires the use of proper nozzle designed and manufactured with a special internal profile to provide high values of impact and a consistent flow jet spray along the descaling process. The general composition of a descaling nozzle is shown in the picture at the right.

Only GW type is different, as it is integrated only by nipple, nozzle and locknut.

## IMPACT MEASUREMENT

Our descaling nozzles are tested by means of a three-dimensional testing machine that measures the spray jet impact and distribution. A load cell, placed at the bottom of the nozzle, moves along the path of the spray jet measuring its force of impact millimeter by millimeter.

The pressure values with respect to the surface to be descaled, angle of inclination and offset angle, can be varied according to the technical specifications required by customers.

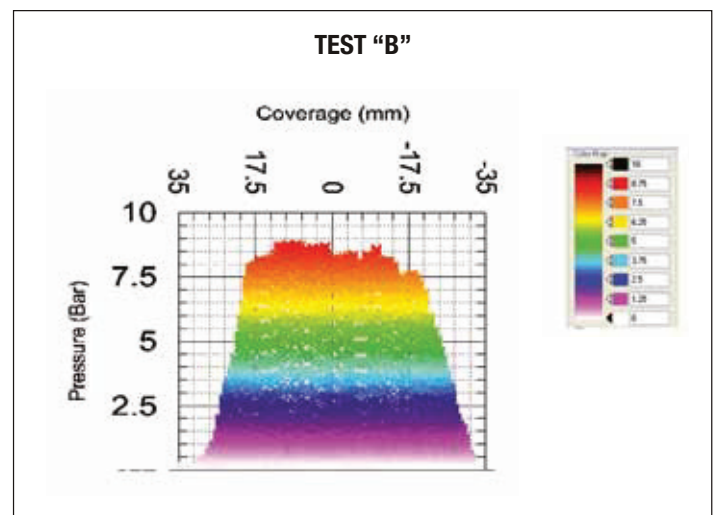
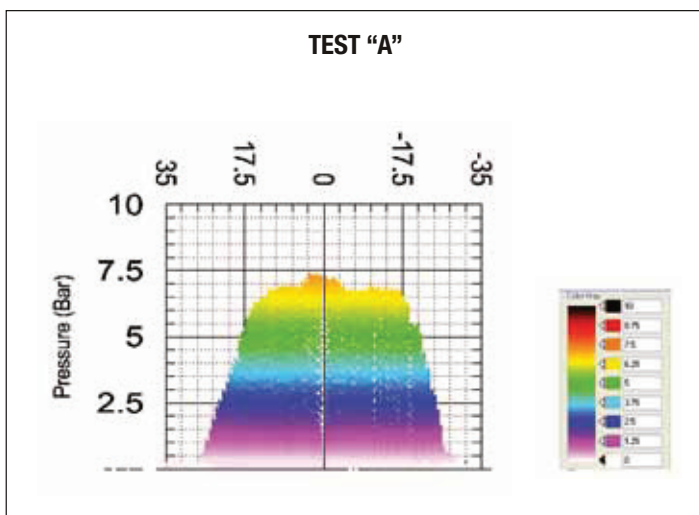
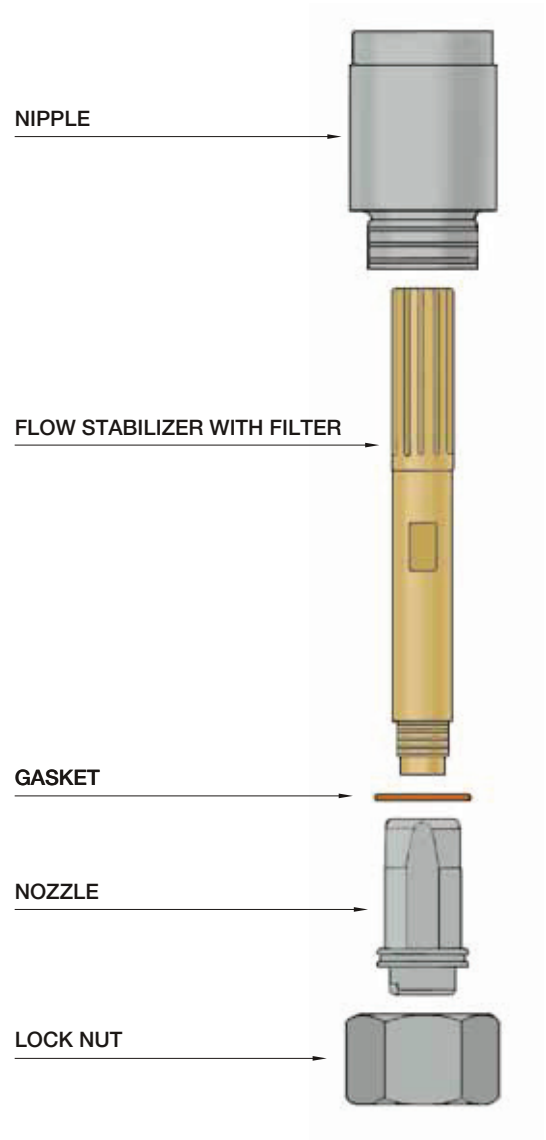

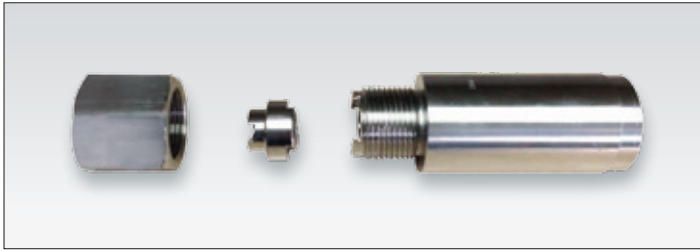
**GW Type**

Dovetail nozzles

pag. 40

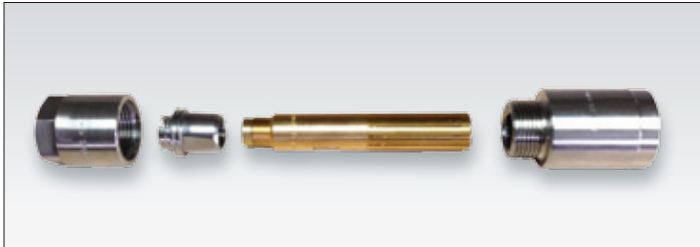
**HW / AH Type**

Short Nozzles - Standard size

pag. 42

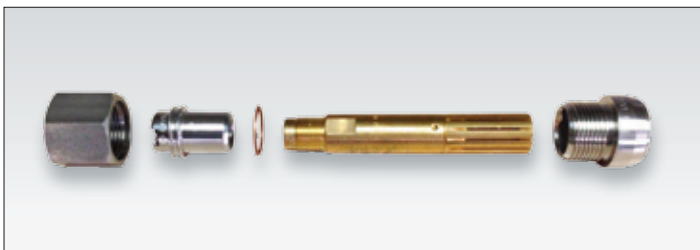
**HW / AA Type**

Short Nozzles - Mini Size

pag. 44

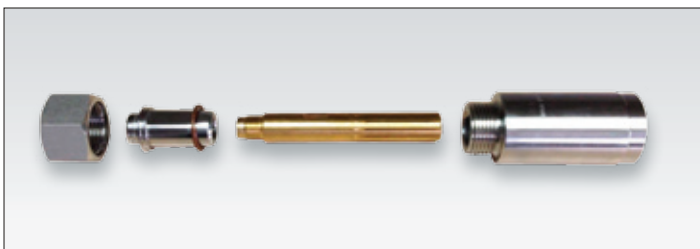
**HW / AK Type**

High Impact - Standard Size

pag. 46

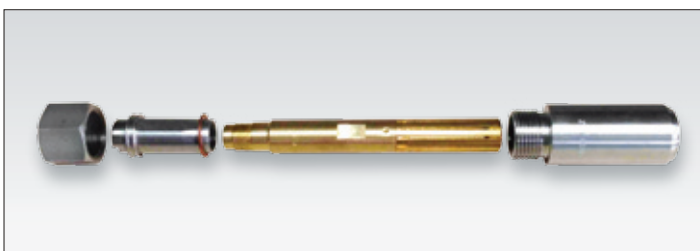
**HW / AB Type**

High Impact - Mini Size

pag. 48

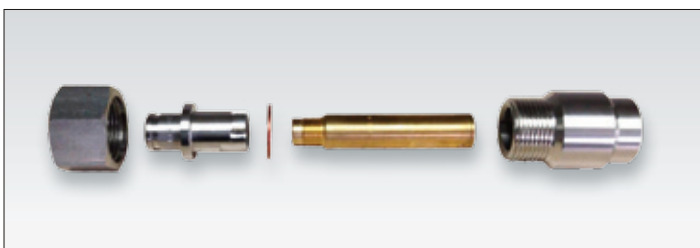
**HV / AH Type**

High Impact - Special Size

pag. 50

**HW / AM Type**

High Impact - Micro Size

pag. 52

## DOVE-TAIL NOZZLES

GW series nozzles have been the worldwide standard for many years in hot descaling mills. They have undergone many improvements, specifically to the inner orifice profile, resulting in a very even distribution of the water jet impact onto the steel surface. Their typical design with a dove-tail coupling between nipple and nozzle tip assures for correct alignment of the nozzle onto the spray manifold. Several nipples length value and a specific locknut allow for a wide choice of different assembly dimensions.



### SPRAY PATTERN

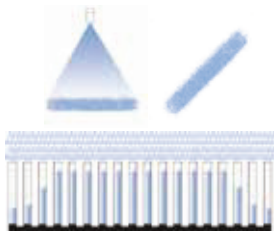

### OFFSET ANGLE

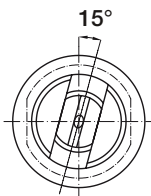

### DIMENSIONS

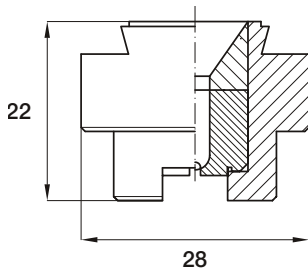

### SPRAY ANGLE CODES

GWC	GWE	GWF	GWL
22°	26°	30°	40°

### MATERIALS

		WEIGHT (Kg)	
<b>C1</b>	Body	Stainless steel AISI 303	0.07*
	Insert	Stainless steel AISI 420 hardened	
<b>F1</b>	Body	Stainless steel AISI 303	0.08*
	Insert	Tungsten carbide	

\* Average Value

### HOW TO ORDER PNR PRODUCTS

Model	Angle	Capacity	Material
<b>GW</b>	<b>C</b>	<b>2162</b>	<b>XX</b>

Order example: **GWC 2162 C1**

**D** = Nozzle orifice conventional diameter (mm)

**D<sub>1</sub>** = Minimum internal passage diameter (mm)

Code	D mm	D <sub>1</sub> mm	Capacity - lpm							
			Pressure - bar							
			80	90	100	120	140	160	180	200
2162xx	2.0	1.5	16.2	17.1	18.0	19.5	21.3	22.8	24.0	25.0
2208xx	2.1	1.8	20.8	21.8	23.0	25.2	27.2	29.1	30.8	35.5
2250xx	2.5	1.9	25.0	26.5	28.0	31.0	33.0	35.4	37.5	39.0
2320xx	2.8	2.4	32.0	34.2	36.0	39.4	42.6	45.5	48.3	50.9
2402xx	3.0	2.5	40.2	42.7	45.0	49.0	53.0	57.0	60.0	63.0
2520xx	3.5	2.7	52.0	55.0	58.0	63.5	68.6	73.3	77.8	82.0
2642xx	3.8	3.2	64.2	68.3	72.0	78.0	85.0	91.0	96.0	101
2798xx	4.3	3.6	79.8	84.4	89.0	98.0	105	112	119	126
2996xx	4.7	4.0	99.6	106	112	122	132	141	150	158
3112xx	5.0	4.2	112	119	125	137	148	158	168	177
3120xx	5.2	4.4	120	127	134	147	158	169	180	189

### CONVERSION TABLE (UE - USA)

<b>PRESSURE: 1 bar = 14,5 psi</b>	<b>CAPACITY: 1 lpm = 0,264 gpm</b>
-----------------------------------	------------------------------------



**ZB NIPPLES**

ZB series welding nipples have been designed for the assembling of GW descaling tips onto main manifolds. The accurately machined dove-tail profile assures for precise alignment of the nozzle tip with respect to the axis of the spray manifold. The contact area with the nozzle tip shows a surface machined to an accurate finish to prevent leakage between nipple and nozzle tip. ZB nipples are available in three length values to match different dimensional requirements.

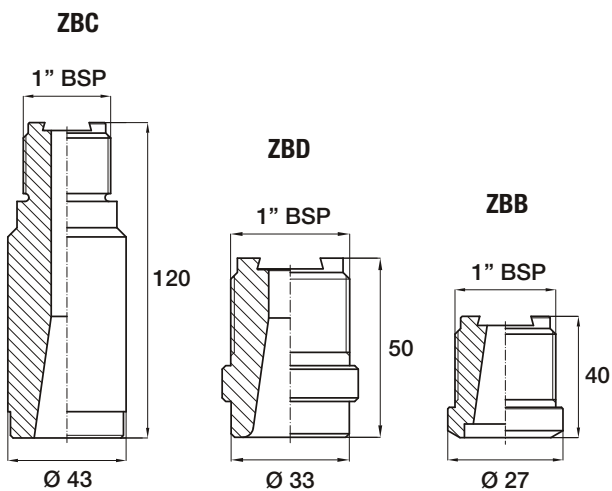

**MATERIALS**

<b>B31</b>	Stainless steel AISI 316L
------------	---------------------------

Code	RG inch	L mm	Weight Kg
ZBB 0100 B3	1	40	0.18
ZBC 0100 B3	1	120	0.90
ZBD 0100 B3	1	50	0.22



**VAA 1001 B1B**

**VAA 1001 B1B**

The VAA 1001 B1B cap is designed for the proper assembly between ZB nipples and GW descaling nozzle tips. The strong design assures for a safe operation under the high pressure values typically used in hot descaling mill systems.

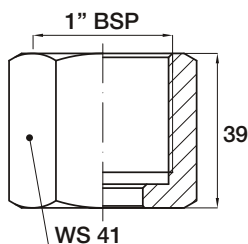

**MATERIALS**

**WEIGHT (Kg)**

<b>B1</b>	Stainless steel AISI 303	0.22*
-----------	--------------------------	-------

\* Average Value



## SHORT NOZZLES - STANDARD SIZE

The modern design of these nozzle offers the convenience of a more rational alignment system, with a copper seal used between nipple and nozzle tip. The nozzle efficiency is enhanced by means of a carefully designed flow stabilizer, which minimizes turbulence due to sharp direction change at the inlet from the main manifold. Provision is also made for a filter to be mounted at the nozzle inlet, minimizing nozzle clogging and abrasion.

### SPRAY PATTERN

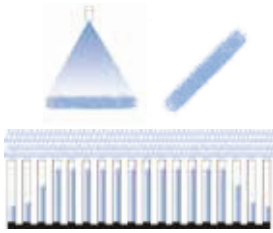

### SPRAY ANGLE CODES

HWC	HWE	HWF	HWL
22°	26°	30°	40°

### MATERIALS

		WEIGHT (Kg)	
<b>C1</b>	Body	Stainless steel AISI 303	0.08*
	Insert	Stainless steel AISI 420 hardened	
<b>F1</b>	Body	Stainless steel AISI 303	0.09*
	Insert	Tungsten carbide	

\* Average Value

### HOW TO ORDER PNR PRODUCTS

Model	Spray Angle	Capacity	Material
HW/AH	C	2045	XX

Order example: **HWC 2045 F1AH**

**D** = Nozzle orifice conventional diameter (mm)

**D<sub>1</sub>** = Minimum internal passage diameter (mm)

### OFFSET ANGLE

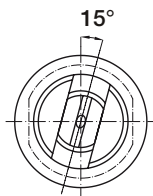

### DIMENSIONS

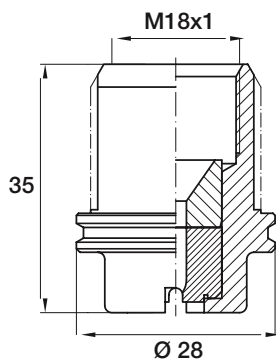

Code	D	D <sub>1</sub>	Capacity - lpm									
			Pressure - bar									
			80	100	140	200	240	280	300	340	380	400
2045 xxAH	0.7	0.6	4.5	5.0	5.9	7.2	7.8	8.5	8.7	9.3	9.8	10.0
2063 xxAH	1.0	0.8	6.3	7.0	8.3	10.0	10.9	11.8	12.2	13.0	13.7	14.1
2106 xxAH	1.5	1.2	10.6	11.9	14.2	16.8	18.4	19.8	20.5	21.8	23.1	23.7
2134 xxAH	1.8	1.4	13.4	15.0	17.7	21.2	23.2	25.0	25.9	27.6	29.2	29.9
2162 xxAH	2.0	1.5	16.2	18.1	21.4	25.6	28.0	30.3	31.4	33.4	35.3	36.2
2208 xxAH	2.1	1.8	20.8	23.3	27.5	32.9	36.0	38.9	40.2	42.9	45.3	46.5
2250 xxAH	2.5	1.9	25.0	28.0	33.0	39.5	43.3	46.8	48.4	51.6	54.5	55.9
2320 xxAH	2.8	2.4	32.0	35.8	42.3	50.6	55.4	59.9	62.0	66.0	69.7	71.6
2402 xxAH	3.0	2.5	40.2	45.0	53.2	63.6	69.6	75.2	77.8	82.9	87.6	89.9
2520 xxAH	3.5	2.7	52.0	58.1	68.8	82.2	90.0	97.3	100.7	107.2	113.3	116.3
2642 xxAH	3.8	3.2	64.2	71.8	84.9	101.5	111.2	120.1	124.3	132.3	140.0	143.6
2798 xxAH	4.3	3.6	79.8	89.2	105.6	126.0	138.2	149.3	154.5	164.5	174.0	178.4
2996 xxAH	4.7	4.0	99.6	111.3	131.8	157.5	172.5	186.3	192.8	205.3	217.0	222.7
3112 xxAH	5.0	4.2	112.0	125.2	148.2	177.0	194.0	209.5	216.9	231.0	244.0	250.4
3120 xxAH	5.2	4.4	120.0	134.2	158.7	189.7	207.8	224.5	232.4	247.4	261.5	268.3



### ALIGNMENT NOZZLE

Alignment blind nozzle HWZ 01Cx B1 allows for fast and safe positioning of the nipple on the manifold prior to welding. The nipple is aligned in place by means of a straight rod and welded to assure the right jet direction.



### DISASSEMBLY KIT

Nozzle tip is strongly secured to the nipple and its removal is not always easy and can cause damage to both parts. HWZ 05B0 B1 disassembling kit allows a safe gripping of the nozzle and makes it easier to apply the tensile strength required to extract it from inside the nipple, for replacement and inspection. The kit is sold separately. Ask for the technical data sheet to select the correct tip for the required alignment angle.

NUT	VAW B100 B1								
NIPPLE	ZWB 0073 B2			ZWB 0100 B2			ZWB 0120 B2		
STABILIZER	A	B	C	A	B	C	A	B	C
XHW CG10 T1				116	100		136	120	
XHW CG20 T1							136	120	

A = Complete Descaling unit Length (mm)  
 B = Welding Nipple Length (mm)  
 C = Flow Straightener Protrusion (mm)

NUT	VAW B100 B1								
NIPPLE	ZWB 0073 B2			ZWB 0100 B2			ZWB 0120 B2		
STABILIZER	A	B	C	A	B	C	A	B	C
XHW CG10 T1	97	73	10						
XHW CG20 T1	133	73	34	133	100	17			
XHW CG21 T1	153	73	54	153	100	37	153	120	17

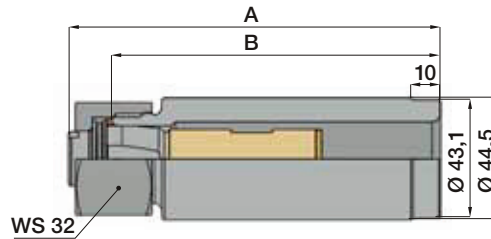

NUT VAW D100 B1

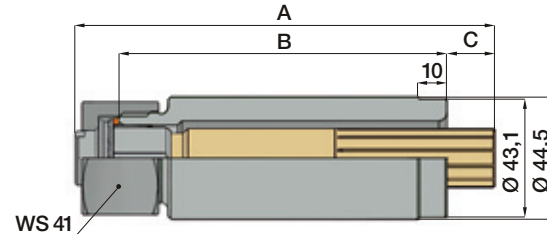
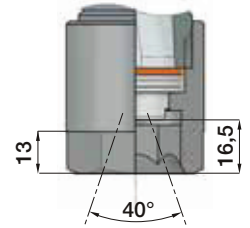

ZWB

**WELDING NIPPLE**

HW nozzles can be assembled on a variety of different nipples, with the same inlet, but with different lengths. The precision machined nipple inlet port assures precise positioning of the nozzle flat fan jet to the specified offset angle value of 15° with regard to manifold center line. This makes it possible to obtain uniform impact distribution yielding better decaling results.

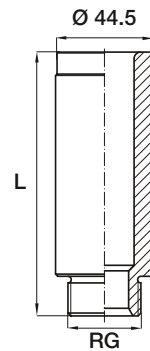

**MATERIALS**

<b>B2</b>	Stainless steel AISI 304		
<b>B3</b>	Stainless steel AISI 316L		
Code	RG inch	L mm	Weight Kg
ZWB 0073 B2	1	73	0.49
ZWB 0100 B2	1	100	0.71
ZWB 0120 B2	1	120	0.85



XHW

**FLOW STABILIZER**

The flow stabilizer is a critical component for proper descaling, by reducing flow turbulence losses, a larger fraction of the water flow energy can be used for generating impact on the surface to be descaled. The design consists of a cylindrical brass body with a polished inner surface, housing a cast stainless steel flow stabilizer which straightens the liquid path to minimize turbulences. Different length nipples are available, with or without inlet filter. The codes always include a multifin flow straightener.

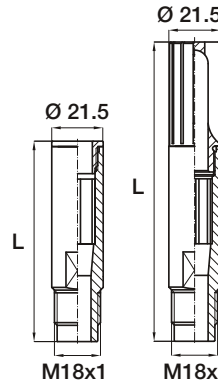

**MATERIALS**

<b>T1</b>	Body	Brass	
	Filter	Brass	
	Flow stabilizer	Stainless steel AISI 316	
Code	L mm	Weight Kg	Notes
XHW CG10 T1	74	0.12	without filter
XHW CG20 T1	110.5	0.18	with filter
XHW CG21 T1	130.5	0.20	with filter



VAW B100 B1

VAW D100 B1

**LOCKNUTS**

The VAW B 100 B1 and VAW D 100 B1 locknuts for ZWB series descaling nipples have been designed profiting from a large experience on the field. The sturdy design and the generous dimensions give the maximum protection to the nozzle and the nipple thread. One locknut size fits all standard size ZWB series nipple of any length.

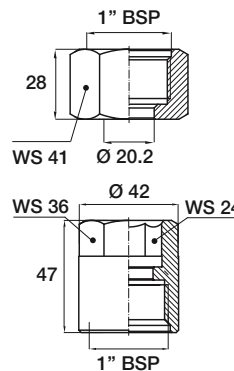

**MATERIALS**

<b>B1</b>	Stainless steel AISI 303	
Code	Notes	Weight Kg
VAW B100 B1	Outside exagone	0.16
VAW D100 B1	Built in exagone	0.25



VDA 24C1 T3

**GASKET**

The VDA 24C1 T3 round gasket provides proper assembly between nozzle and nipple. One size fits all standard size ZWB nipple types.

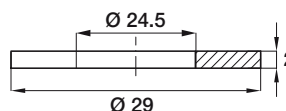

**MATERIALS**

<b>T3</b>	Copper	<b>Code</b> VDA 24C1 T3
-----------	--------	----------------------------

### SHORT NOZZLES - MINI SIZE

The modern design of these nozzle offers the same advantage as the full size HW nozzles. In addition it makes possible to use a smaller pitch between the nozzles allowing for a higher impact value per unit length. The nozzle efficiency is enhanced by means of a carefully designed flow stabilizer, which minimizes turbulence due to sharp direction change at the inlet from the main manifold. Provision is also made for a filter to be mounted at the nozzle inlet, minimizing nozzle clogging and abrasion.



#### SPRAY PATTERN

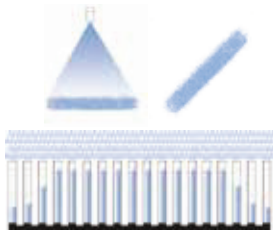

#### SPRAY ANGLE CODES

HWC	HWE	HWF	HWL
22°	26°	30°	40°

#### MATERIALS

			WEIGHT (Kg)
<b>C1</b>	Body	Stainless steel AISI 303	0.07*
	Insert	Stainless steel AISI 420 hardened	
<b>F1</b>	Body	Stainless steel AISI 303	0.08*
	Insert	Tungsten carbide	

\* Average Value

#### HOW TO ORDER PNR PRODUCTS

Model	Angle	Capacity	Material
HW/AA	C	2045	XX

Order example: **HWC 2045 F1AA**

#### OFFSET ANGLE

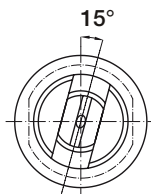

#### DIMENSIONS

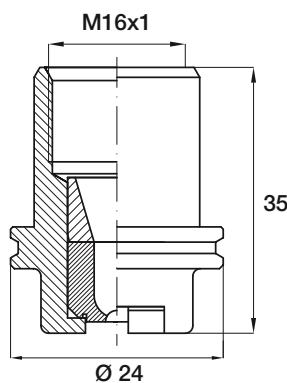

**D** = Nozzle orifice conventional diameter (mm)      **D<sub>1</sub>** = Minimum internal passage diameter (mm)

Code	D	D1	Capacity - lpm									
			Pressure - bar									
			80	100	140	200	240	280	300	340	380	400
2045 xxAA	0.7	0.6	4.5	5.0	5.9	7.2	7.8	8.5	8.7	9.3	9.8	10.0
2063 xxAA	1.0	0.8	6.3	7.0	8.3	10.0	10.9	11.8	12.2	13	13.7	14.1
2106 xxAA	1.5	1.2	10.6	11.9	14.2	16.8	18.4	19.8	20.5	21.8	23.1	23.7
2134 xxAA	1.8	1.4	13.4	15.0	17.7	21.2	23.2	25.0	25.9	27.6	29.2	29.9
2162 xxAA	2.0	1.5	16.2	18.1	21.4	25.6	28.0	30.3	31.4	33.4	35.3	36.2
2208 xxAA	2.1	1.8	20.8	23.3	27.5	32.9	36.0	38.9	40.2	42.9	45.3	46.5
2250 xxAA	2.5	1.9	25.0	28.0	33.0	39.5	43.3	46.8	48.4	51.6	54.5	55.9
2320 xxAA	2.8	2.4	32.0	35.8	42.3	50.6	55.4	59.9	62.0	66.0	69.7	71.6
2402 xxAA	3.0	2.5	40.2	45.0	53.2	63.6	69.6	75.2	77.8	82.9	87.6	89.9
2520 xxAA	3.5	2.7	52.0	58.1	68.8	82.2	90.0	97.3	100.7	107.2	113.3	116.3
2642 xxAA	3.8	3.2	64.2	71.8	84.9	101.5	111.2	120.1	124.3	132.3	140.0	143.6
2798 xxAA	4.3	3.6	79.8	89.2	105.6	126.0	138.2	149.3	154.5	164.5	174.0	178.4
2996 xxAA	4.7	4.0	99.6	111.3	131.8	157.5	172.5	186.3	192.8	205.3	217.0	222.7
3112 xxAA	5.0	4.2	112.0	125.2	148.2	177.0	194.0	209.5	216.9	231.0	244.0	250.4
3120 xxAA	5.2	4.4	120.0	134.2	158.7	189.7	207.8	224.5	232.4	247.4	261.5	268.3



#### ALIGNMENT NOZZLE

Alignment blind nozzle HWZ 01AxB1 allows for fast and safe positioning of the nipple on the manifold prior to welding. The nipple is aligned in place by means of a straight rod and welded to assure the right jet direction.



#### DISASSEMBLY KIT

Nozzle tip is strongly secured to the nipple and its removal is not always easy and can cause damage to both parts. HWZ 05A0 B1 disassembling kit makes a safe gripping of the nozzle and makes it easier to apply the tensile strength required to extract it from inside the nipple, for replacement and inspection. The kit is sold separately. Ask for the technical data sheet to select the correct tip for the required alignment angle.

NUT	VAW A075 B1								
NIPPLE	ZWA 0032 B2			ZWA 0039 B2			ZWA 0080 B2		
STABILIZER	A	B	C	A	B	C	A	B	C
XHW AG10 T1	97	32	49	97	39	42	97	80	2
XHW AG20 T1	133	32	86.5	133	39	79.5	133	80	38.5
XHW AG21 T1	153	32	106.5	153	39	99.5	153	80	58.5

A = Complete Descaling unit Length (mm)  
 B = Welding Nipple Length (mm)  
 C = Flow Straightener Protrusion (mm)

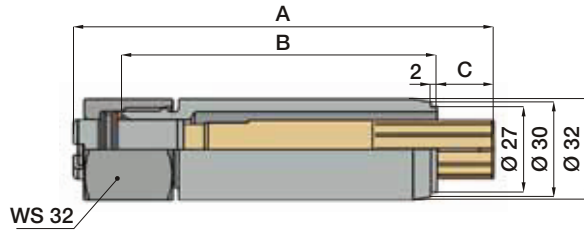

NUT VAW C075 B1

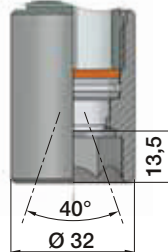

ZWA

WELDING NIPPLES

HW small size nozzles can be assembled on a variety of welding nipples, with same inlet, and different lengths. The precision machined nipple inlet port assures precise positioning of the nozzle flat fan jet to the specified offset angle value of 15° with regard to manifold center line. This makes possible to obtain uniform impact distribution yielding better decaling results.

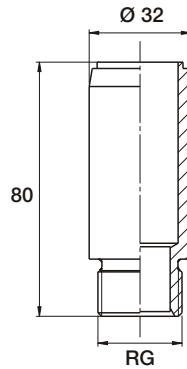

MATERIALS

B2	Stainless steel AISI 304		
B3	Stainless steel AISI 316L		
Code	RG	L	Weight
	inch	mm	Kg
ZWA 0032 B2	3/4	32	0.06
ZWA 0039 B2	3/4	39	0.08
ZWA 0080 B2	3/4	80	0.19



XHW

FLOW STABILIZER

The flow stabilizer is a critical component for proper descaling, by reducing flow turbulence losses, a larger fraction of the water flow energy can be used for generating impact on the surface to be descaled. The design consists of a cylindrical brass body with a polished inner surface, housing a cast stainless steel flow stabilizer which straightens the liquid path to minimize turbulences. Different length nipples are available, with or without inlet filter. The codes always include a multifin flow straightener.

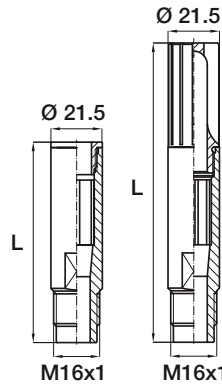

MATERIALS

T1	Body	Brass	
	Filter	Brass	
	Flow stabilizer	Stainless steel AISI 316 L	
Code	L	Weight	Notes
	mm	Kg	
XHW AG10 T1	74.0	0.09	without filter
XHW AG20 T1	110.5	0.14	with filter
XHW AG21 T1	130.5	0.16	with filter



VAW A075 B1

VAW C075 B1

LOCKNUTS

The VAW A075 B1 and VAW C075 B1 locknuts for ZWA series descaling nipples have been designed profiting from a large experience on the field. The sturdy design and the generous dimensions give the maximum protection to the nozzle and the nipple thread. One locknut size fits all standard size ZWA series nipple of any length.

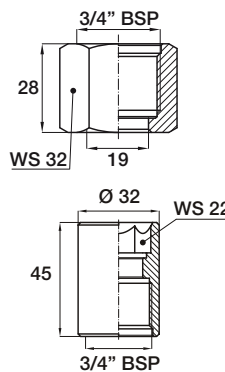

MATERIALS

B1	Stainless steel AISI 303	
Code	Notes	Weight
		Kg
VAW A075 B1	Outside exagone	0.09
VAW C075 B1	Built in exagone	0.12



VDA 20C1 T3

GASKET

The VDA 20C1 T3 round gasket provides proper assembly between nozzle and nipple. One size fits all small size ZWA nipple types.

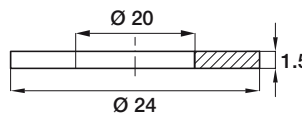

MATERIALS

T3	Copper	VDA 20C1 T3
----	--------	-------------





**HIGH IMPACT NOZZLES - STANDARD SIZE**

The water path leading to the nozzle orifice has been completely redesigned to reduce energy losses caused by turbulence, all sharp cross section changes have been eliminated resulting in a significant increase in water velocity at the nozzle orifice.

The afore mentioned advantages are added to those offered by a carefully designed flow stabilizer and a filter when assembled to the nipple inlet, minimizing clogging and abrasion of the nozzle orifice.

**SPRAY PATTERN**

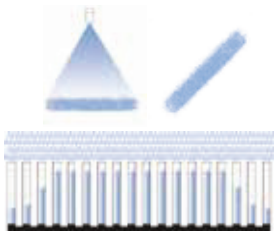

**SPRAY ANGLE CODES**

HWC	HWE	HWF	HWL
22°	26°	30°	40°

**MATERIALS**

			WEIGHT (Kg)
<b>C1</b>	Body	Stainless steel AISI 303	0.14*
	Insert	Stainless steel AISI 420 hardened	
<b>F1</b>	Body	Stainless steel AISI 303	0.15*
	Insert	Tungsten carbide	

\* Average Value

**HOW TO ORDER PNR PRODUCTS**

Model	Spray Angle	Capacity	Material
<b>HW/AK</b>	<b>C</b>	<b>2045</b>	<b>XX</b>

Order example: **HWC 2045 F1AK**

**D** = Nozzle orifice conventional diameter (mm)

**D<sub>1</sub>** = Minimum internal passage diameter (mm)

**OFFSET ANGLE**

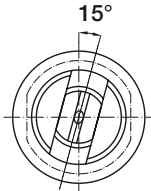

**DIMENSIONS**

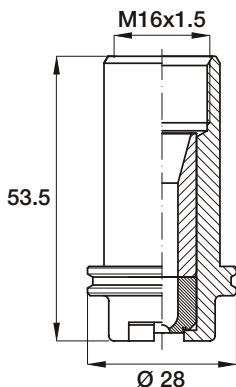

Code	D	D1	Capacity - lpm									
			Pressure - bar									
			80	100	140	200	240	280	300	340	380	400
2045 xxAK	0.7	0.6	4.5	5.0	5.9	7.2	7.8	8.5	8.7	9.3	9.8	10.0
2063 xxAK	1.0	0.8	6.3	7.0	8.3	10.0	10.9	11.8	12.2	13.0	13.7	14.1
2106 xxAK	1.5	1.2	10.6	11.9	14.2	16.8	18.4	19.8	20.5	21.8	23.1	23.7
2134 xxAK	1.8	1.4	13.4	15.0	17.7	21.2	23.2	25.0	25.9	27.6	29.2	29.9
2162 xxAK	2.0	1.5	16.2	18.1	21.4	25.6	28.0	30.3	31.4	33.4	35.3	36.2
2208 xxAK	2.1	1.8	20.8	23.3	27.5	32.9	36.0	38.9	40.2	42.9	45.3	46.5
2250 xxAK	2.5	1.9	25.0	28.0	33.0	39.5	43.3	46.8	48.4	51.6	54.5	55.9
2320 xxAK	2.8	2.4	32.0	35.8	42.3	50.6	55.4	59.9	62.0	66.0	69.7	71.6
2402 xxAK	3.0	2.5	40.2	45.0	53.2	63.6	69.6	75.2	77.8	82.9	87.6	89.9
2520 xxAK	3.5	2.7	52.0	58.1	68.8	82.2	90.0	97.3	100.7	107.2	113.3	116.3
2642 xxAK	3.8	3.2	64.2	71.8	84.9	101.5	111.2	120.1	124.3	132.3	140.0	143.6
2798 xxAK	4.3	3.6	79.8	89.2	105.6	126.0	138.2	149.3	154.5	164.5	174.0	178.4
2996 xxAK	4.7	4.0	99.6	111.3	131.8	157.5	172.5	186.3	192.8	205.3	217.0	222.7
3112 xxAK	5.0	4.2	112.0	125.2	148.2	177.0	194.0	209.5	216.9	231.0	244.0	250.4
3120 xxAK	5.2	4.4	120.0	134.2	158.7	189.7	207.8	224.5	232.4	247.4	261.5	268.3



**ALIGNMENT NOZZLE**

Alignment blind nozzle HWZ 01Cx B1 allows for fast and safe positioning of the nipple on the manifold prior to welding. The nipple is aligned in place by means of a straight rod and welded to assure the right jet direction.



**DISASSEMBLY KIT**

Nozzle tip is strongly secured to the nipple and its removal is not always easy and can cause damage to both parts. HWZ 05B0 B1 disassembling kit allows a safe gripping of the nozzle and makes it easier to apply the tensile strength required to extract it from inside the nipple, for replacement and inspection. The kit is sold separately. Ask for the technical data sheet to select the correct tip for the required alignment angle.

NUT	VAW B100 B1								
NIPPLE	ZWB 0073 B2	ZWB 0100 B2	ZWB 0120 B2			ZWB 0120 B2			
STABILIZER	A	B	C	A	B	C	A	B	C
XHW DG10 T1				116	100		136	120	
XHW DG20 T1							136	120	

A = Complete Descaling unit Length (mm)  
 B = Welding Nipple Length (mm)  
 C = Flow Straightener Protrusion (mm)

NUT	VAW B100 B1								
NIPPLE	ZWB 0073 B2	ZWB 0100 B2	ZWB 0120 B2			ZWB 0120 B2			
STABILIZER	A	B	C	A	B	C	A	B	C
XHW DG10 T1	116	73	26						
XHW DG20 T1	136	73	46	136	100	19			
XHW DG21 T1	149	73	60	149	100	33	149	120	13
XHW DG21 T1	169	73	80	169	100	53	169	120	33
XHW DG22 T1	189	73	100	189	100	73	189	120	53

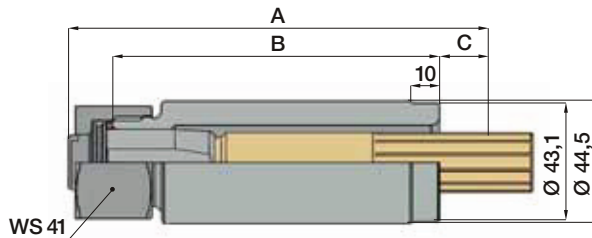
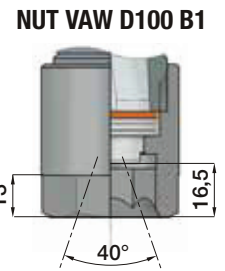
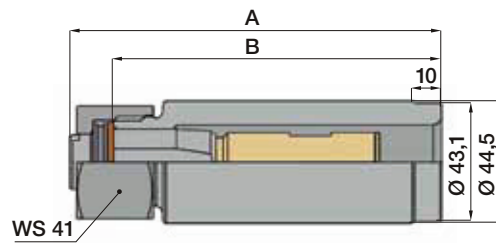

WELDING NIPPLES

HW nozzles can be assembled on a variety of different nipples, with the same inlet, but with different lengths. The precision machined nipple inlet port assures precise positioning of the nozzle flat fan jet to the specified offset angle value of 15° with regard to manifold center line. This makes it possible to obtain uniform impact distribution yielding better descaling results.

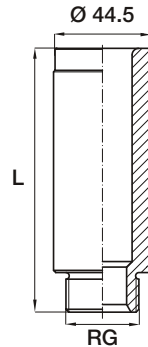

MATERIALS

B2	Stainless steel AISI 304		
B3	Stainless steel AISI 316L		
Code	RG	L	Weight
	inch	mm	Kg
ZWB 0073 B2	1	73	0.48
ZWB 0100 B2	1	100	0.70
ZWB 0120 B2	1	120	0.84



FLOW STABILIZER

The flow stabilizer is a critical component for proper descaling, by reducing flow turbulence losses, a larger fraction of the water flow energy can be used for generating impact on the surface to be descaled. The design consists of a cylindrical brass body with a polished inner surface, housing a cast stainless steel flow stabilizer which straightens the liquid path to minimize turbulences. Different length nipples are available, with or without inlet filter. The codes always include a multifin flow straightener.

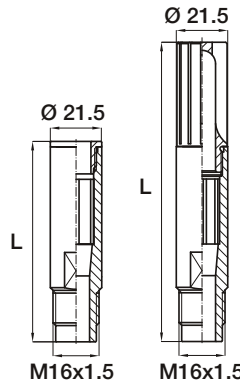

MATERIALS

T1	Body	Brass	
	Filter	Brass	
	Flow stabilizer	Stainless steel AISI 316	
Code	L	Weight	Notes
	mm	Kg	
XHW DG 10 T1	76	0.08	without filter
XHW DG 11 T1	96	0.10	without filter
XHW DG 20 T1	110	0.12	with filter
XHW DG 21 T1	130	0.14	with filter
XHW DG 22 T1	150	0.15	with filter



LOCKNUTS

The VAW B 100 B1 and VAW D 100 B1 locknuts for ZWB series descaling nipples have been designed profiting from a large experience on the field. The sturdy design and the generous dimensions give the maximum protection to the nozzle and the nipple thread. One locknut size fits all standard size ZWB series nipple of any length.

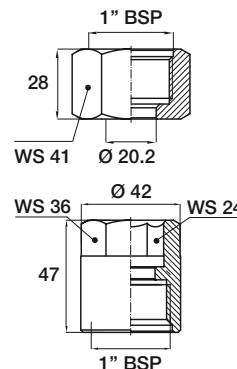

MATERIALS

B1	Stainless steel AISI 303	
Code	Notes	Weight
		Kg
VAW B100 B1	Outside exagone	0.16
VAW D100 B1	Built in exagone	0.24



GASKET

The VDA 24C1 T3 round gasket provides proper assembly between nozzle and nipple. One size fits all standard size ZWB nipple types.

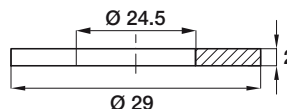

MATERIALS

T3	Copper	VDA 24C1 T3
----	--------	-------------



## HIGH IMPACT NOZZLES - MINI SIZE

The water path leading to the nozzle orifice has been completely redesigned to reduce energy losses caused by turbulence, all sharp cross section changes have been eliminated resulting in a significant increase in water velocity at the nozzle orifice.

The afore mentioned advantages are added to those offered by a carefully designed flow stabilizer and a filter when assembled to the nipple inlet, minimizing clogging and abrasion of the nozzle orifice.

### SPRAY PATTERN

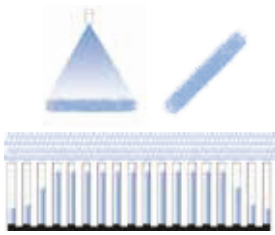

### SPRAY ANGLE CODES

HWC	HWE	HWF	HWL
22°	26°	30°	40°

### MATERIALS

			WEIGHT (Kg)
<b>C1</b>	Body	Stainless steel AISI 303	0.10*
	Insert	Stainless steel AISI 420 hardened	
<b>F1</b>	Body	Stainless steel AISI 303	0.11*
	Insert	Tungsten carbide	

\* Average Value

### HOW TO ORDER PNR PRODUCTS

Model	Spray Angle	Capacity	Material
<b>HW/AB</b>	<b>C</b>	<b>2045</b>	<b>XX</b>

Order example: **HWC 2045 F1AB**

**D** = Nozzle orifice conventional diameter (mm)

**D<sub>1</sub>** = Minimum internal passage diameter (mm)

### OFFSET ANGLE

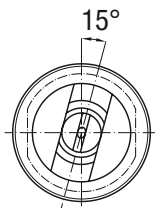

### DIMENSIONS

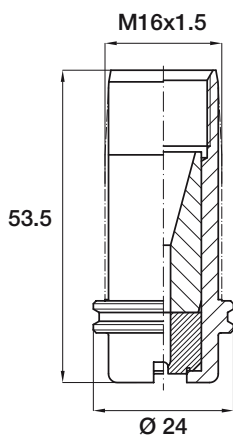

Code	D	D1	Capacity - lpm									
			Pressure - bar									
			80	100	140	200	240	280	300	340	380	400
2045 xxAB	0.7	0.6	4.5	5.0	5.9	7.2	7.8	8.5	8.7	9.3	9.8	10.0
2063 xxAB	1.0	0.8	6.3	7.0	8.3	10	10.9	11.8	12.2	13	13.7	14.1
2106 xxAB	1.5	1.2	10.6	11.9	14.2	16.8	18.4	19.8	20.5	21.8	23.1	23.7
2134 xxAB	1.8	1.4	13.4	15.0	17.7	21.2	23.2	25.0	25.9	27.6	29.2	29.9
2162 xxAB	2.0	1.5	16.2	18.1	21.4	25.6	28.0	30.3	31.4	33.4	35.3	36.2
2208 xxAB	2.1	1.8	20.8	23.3	27.5	32.9	36.0	38.9	40.2	42.9	45.3	46.5
2250 xxAB	2.5	1.9	25.0	28.0	33.0	39.5	43.3	46.8	48.4	51.6	54.5	55.9
2320 xxAB	2.8	2.4	32.0	35.8	42.3	50.6	55.4	59.9	62.0	66.0	69.7	71.6
2402 xxAB	3.0	2.5	40.2	45.0	53.2	63.6	69.6	75.2	77.8	82.9	87.6	89.9
2520 xxAB	3.5	2.7	52.0	58.1	68.8	82.2	90.0	97.3	100.7	107.2	113.3	116.3
2642 xxAB	3.8	3.2	64.2	71.8	84.9	101.5	111.2	120.1	124.3	132.3	140.0	143.6
2798 xxAB	4.3	3.6	79.8	89.2	105.6	126.0	138.2	149.3	154.5	164.5	174.0	178.4
2996 xxAB	4.7	4.0	99.6	111.3	131.8	157.5	172.5	186.3	192.8	205.3	217.0	222.7
3112 xxAB	5.0	4.2	112.0	125.2	148.2	177.0	194.0	209.5	216.9	231.0	244.0	250.4
3120 xxAB	5.2	4.4	120.0	134.2	158.7	189.7	207.8	224.5	232.4	247.4	261.5	268.3



### ALIGNMENT NOZZLE

Alignment blind nozzle HWZ 01Ax B1 allows for fast and safe positioning of the nipple on the manifold prior to welding. The nipple is aligned in place by means of a straight rod and welded to assure the right jet direction.



### DISASSEMBLY KIT

Nozzle tip is strongly secured to the nipple and its removal is not always easy and can cause damage to both parts. HWZ 05AO B1 disassembling kit allows a safe gripping of the nozzle and makes it easier to apply the tensile strength required to extract it from inside the nipple, for replacement and inspection. The kit is sold separately Ask for the technical data sheet to select the correct tip for the required alignment angle.

NUT	VAW A075 B1								
NIPPLE	ZWA 0032 B2			ZWA 0039 B2			ZWA 0080 B2		
STABILIZER	A	B	C	A	B	C	A	B	C
XHW DG10 T1	115	32	67	115	39	61	115	80	20
XHW DG11 T1	135	32	87	135	39	81	135	80	40
XHW DG20 T1	149	32	101	149	39	95	149	80	54
XHW DG21 T1	169	32	121	169	39	115	169	80	74
XHW DG22 T1	189	32	141	189	39	135	189	39	94

**A** = Complete Descaling unit Length (mm)  
**B** = Welding Nipple Length (mm)  
**C** = Flow Straightener Protrusion (mm)

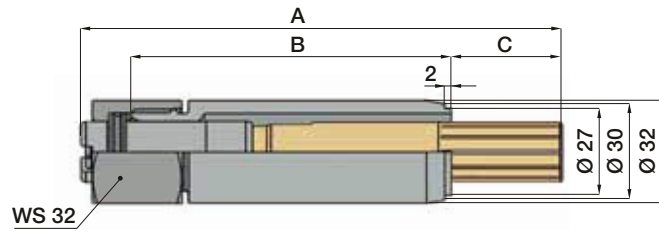

NUT VAW C075 B1

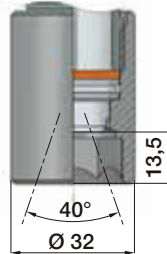

ZWA

WELDING NIPPLES

HW small size nozzles can be assembled on a variety of welding nipples, with same inlet, and different lengths. The precision machined nipple inlet port assures precise positioning of the nozzle flat fan jet to the specified offset angle value of 15° with regard to manifold center line. This makes possible to obtain uniform impact distribution yielding better decaling results.

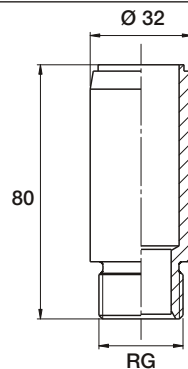

MATERIALS

<b>B2</b>	Stainless steel AISI 304		
Code	RG inch	L mm	Weight Kg
ZWA 0032 B2	3/4	32	0.08
ZWA 0039 B2	3/4	39	0.10
ZWA 0080 B2	3/4	80	0.23



XHW

FLOW STABILIZER

The flow stabilizer is a critical component for proper descaling, by reducing flow turbulence losses, a larger fraction of the water flow energy can be used for generating impact on the surface to be descaled. The design consists of a cylindrical brass body with a polished inner surface, housing a cast stainless steel flow stabilizer which straightens the liquid path to minimize turbulences. Different length nipples are available, with or without inlet filter. The codes always include a multifin flow straightener.

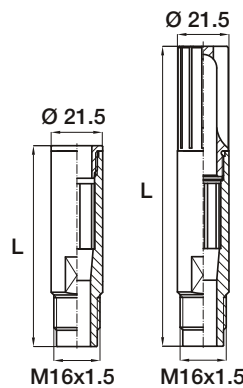

MATERIALS

<b>T1</b>	Body	Brass	
	Filter	Brass	
<b>B3</b>	Flow stabilizer	Stainless steel AISI 316	
Code	L mm	Weight Kg	Notes
XHW DG 10 T1	76	0.08	without filter
XHW DG 11 T1	96	0.10	without filter
XHW DG 20 T1	110	0.11	with filter
XHW DG 21 T1	130	0.14	with filter
XHW DG 22 T1	150	0.16	with filter



VAW A075 B1

VAW C075 B1

LOCKNUTS

The VAW A075 B1 and VAW C075 B1 locknuts for ZWA series descaling nipples have been designed profiting from a large experience on the field. The sturdy design and the generous dimensions give the maximum protection to the nozzle and the nipple thread. One locknut size fits all standard size ZWA series nipple of any length.

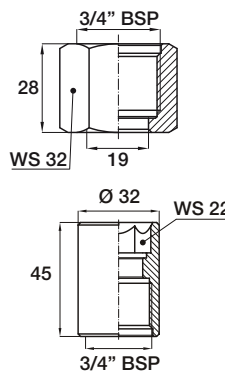

MATERIALS

<b>B1</b>	Stainless steel AISI 303	
Code	Notes	Weight Kg
VAW A075 B1	Outside exagone	0.09
VAW C075 B1	Built in exagone	0.12



VDA 20C1 T3

GASKET

The VDA 20C1 T3 round gasket provides proper assembly between nozzle and nipple. One size fits all small size ZWA nipple types.

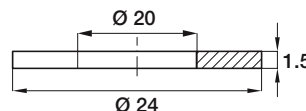

MATERIALS

<b>T3</b>	Copper	<b>VDA 20C1 T3</b>
-----------	--------	--------------------



## HIGH IMPACT NOZZLES - SPECIAL SIZE

High Impact nozzles are widely used in hot rolling processes as they provide an adequate impact for a consistent descaling.

The modern design of these nozzles offers the convenience of a more rational alignment system which allows a copper seal to be used between nipple and nozzle tip. The nozzle efficiency is enhanced by means of a carefully designed flow stabilizer, which minimizes turbulence due to sharp direction change at the inlet from the main manifold. Provision is also made for a filter to be mounted at the nozzle inlet, minimizing nozzle clogging and abrasion.

### SPRAY PATTERN

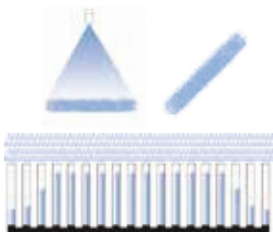

### SPRAY ANGLE CODES

HWC	HWE	HWF	HWL
22°	26°	30°	40°

### MATERIALS

			WEIGHT (Kg)
C1	Body	Stainless steel AISI 303	0.12*
	Insert	Stainless steel AISI 420 hardened	
F1	Body	Stainless steel AISI 303	0.13*
	Insert	Tungsten carbide	

\* Average Value

### HOW TO ORDER PNR PRODUCTS

Model	Spray Angle	Capacity	Material
HV/AH	C	2045	XX

Order example: **HVC 2045 F1AH**

D = Nozzle orifice conventional diameter (mm)

D<sub>1</sub> = Minimum internal passage diameter (mm)

### OFFSET ANGLE

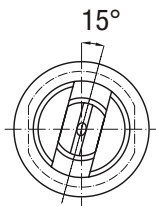

### DIMENSIONS

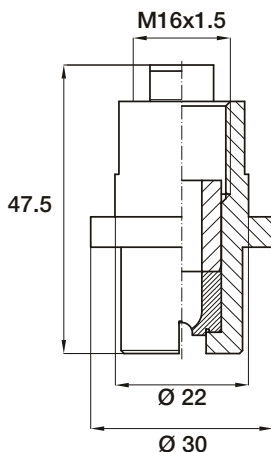

Code	D	D <sub>1</sub>	Capacity - lpm									
			Pressure - bar									
			80	100	140	200	240	280	300	340	380	400
2045 xxAH	0.7	0.6	4.5	5.0	5.9	7.2	7.8	8.5	8.7	9.3	9.8	10.0
2063 xxAH	1.0	0.8	6.3	7.0	8.3	10	10.9	11.8	12.2	13	13.7	14.1
2106 xxAH	1.5	1.2	10.6	11.9	14.2	16.8	18.4	19.8	20.5	21.8	23.1	23.7
2134 xxAH	1.8	1.4	13.4	15.0	17.7	21.2	23.2	25.0	25.9	27.6	29.2	29.9
2162 xxAH	2.0	1.5	16.2	18.1	21.4	25.6	28.0	30.3	31.4	33.4	35.3	36.2
2208 xxAH	2.1	1.8	20.8	23.3	27.5	32.9	36.0	38.9	40.2	42.9	45.3	46.5
2250 xxAH	2.5	1.9	25.0	28.0	33.0	39.5	43.3	46.8	48.4	51.6	54.5	55.9
2320 xxAH	2.8	2.4	32.0	35.8	42.3	50.6	55.4	59.9	62.0	66.0	69.7	71.6
2402 xxAH	3.0	2.5	40.2	45.0	53.2	63.6	69.6	75.2	77.8	82.9	87.6	89.9
2520 xxAH	3.5	2.7	52.0	58.1	68.8	82.2	90.0	97.3	100.7	107.2	113.3	116.3
2642 xxAH	3.8	3.2	64.2	71.8	84.9	101.5	111.2	120.1	124.3	132.3	140.0	143.6
2798 xxAH	4.3	3.6	79.8	89.2	105.6	126.0	138.2	149.3	154.5	164.5	174.0	178.4
2996 xxAH	4.7	4.0	99.6	111.3	131.8	157.5	172.5	186.3	192.8	205.3	217.0	222.7
3112 xxAH	5.0	4.2	112.0	125.2	148.2	177.0	194.0	209.5	216.9	231.0	244.0	250.4
3120 xxAH	5.2	4.4	120.0	134.2	158.7	189.7	207.8	224.5	232.4	247.4	261.5	268.3

### CONVERSION TABLE (UE - USA)

PRESSURE: 1 bar = 14,5 psi

CAPACITY: 1 lpm = 0,264 gpm

NUT	VAW B100 B1					
NIPPLE	ZWC 0062 B2			ZWC 0066 B2		
STABILIZER	A	B	C	A	B	C
XHW DG10 T1	111	62	23	111	66	23
XHW DG11 T1	131	62	43	131	66	43
XHW DG20 T1	145	62	57	145	66	57
XHW DG21 T1	165	62	77	165	66	77
XHW DG22 T1	185	62	97	185	66	97

**A** = Complete Descaling unit Length (mm)  
**B** = Welding Nipple Length (mm)  
**C** = Flow Straightener Protrusion (mm)

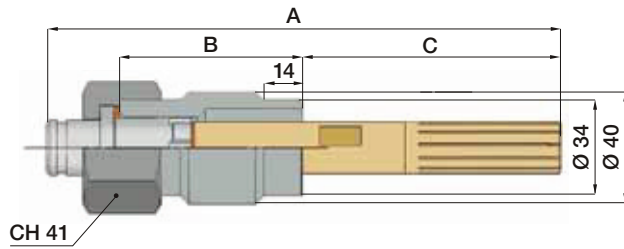

NUT VAW D100 B1

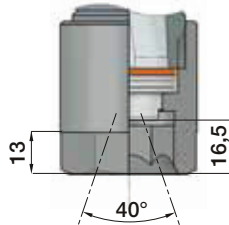

ZWC

WELDING NIPPLES

HV nozzles can be assembled on a series of different nipples, with the same inlet, but with three different lengths. The precision machined nipple inlet port assures precise positioning of the nozzle flat fan jet to the specific offset angle value of 15° with regard to the manifold center line.

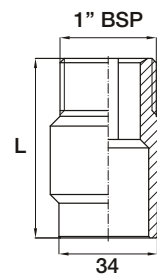

MATERIALS

<b>B2</b>	Stainless steel AISI 304		
Code	RG inch	L mm	Weight Kg
ZWC 0062 B2	1	62	0.65
ZWC 0066 B2	1	66	0.70



XHW

FLOW STABILIZER

The flow stabilizer is a critical component for proper descaling, by reducing flow turbulence losses, a larger fraction of the water flow energy can be used for generating impact on the surface to be descaled. The design consists of a cylindrical brass body with a polished inner surface, housing a cast stainless steel flow stabilizer which straightens the liquid path to minimize turbulences. Different length stabilizers are available, with or without inlet filter. The codes always include a multifin flow straightener.

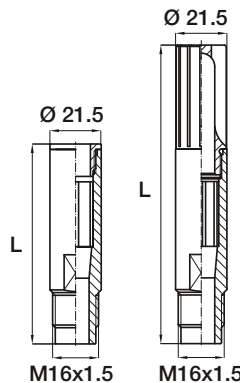

MATERIALS

<b>T1</b>	Body	Brass	
	Filter	Brass	
<b>B3</b>	Flow Stabilizer	Stainless steel AISI 316	
Code	L mm	Weight Kg	Notes
XHW DG 10 T1	76	0.08	without filter
XHW DG 11 T1	96	0.10	without filter
XHW DG 20 T1	110	0.11	with filter
XHW DG 21 T1	130	0.14	with filter
XHW DG 22 T1	150	0.16	with filter



VAW B100 B1

VAW D100 B1

LOCKNUTS

The VAW B100 B1 and VAWD 100 B1 locknuts for ZWC series descaling nipples have been designed profiting from a large experience on the field. The sturdy design and the generous dimensions give the maximum protection to the nozzle and the stabilizer nipple thread. One locknut size fits all standard size ZWB series nipple of any length.

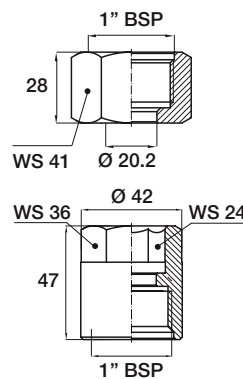

MATERIALS

<b>B1</b>	Stainless steel AISI 303	
Code	Notes	Weight Kg
VAW B100 B1	Outside exagone	0.16
VAW D100 B1	Built in exagone	0.25



VDA 24C1 T3

GASKET

The VDA 24C1 T3 round gasket provides proper assembly between nozzle and nipple. One size fits all standard size ZWB nipple types.

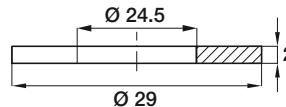

MATERIALS

<b>T3</b>	Copper	<b>VDA 24C1 T3</b>
-----------	--------	--------------------



## HIGH IMPACT NOZZLES - MICRO SIZE

In some plants the centre-to-centre distance among descaling nozzles can be very narrow. In these cases the use of micro-descaling tips avoids the installation of nipples and nozzles or rings onto the spray manifold, which would be difficult, if not impossible, with standard nozzles.

### SPRAY PATTERN

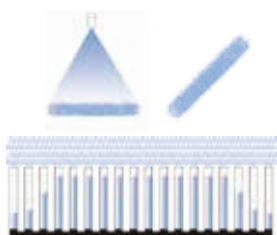

### SPRAY ANGLE CODES

HWC	HWE	HWF	HWL
22°	26°	30°	40°

### MATERIALS

			WEIGHT (Kg)
<b>B1</b>	Body	Stainless steel AISI 303	0.02*
<b>F1</b>	Insert	Tungsten carbide	

\* Average Value

### HOW TO ORDER PNR PRODUCTS

Model	Spray Angle	Capacity	Material
<b>HW/AM</b>	<b>C</b>	<b>2045</b>	<b>XX</b>

Order example: **HWC 2045 F1AM**

### OFFSET ANGLE

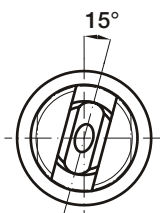

### DIMENSIONS

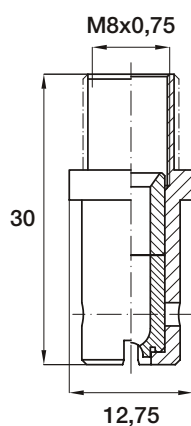

**D** = Nozzle orifice conventional diameter (mm)      **D<sub>1</sub>** = Minimum internal passage diameter (mm)

Code	D	D1	Capacity - lpm									
			Pressure - bar									
			80	100	140	200	240	280	300	340	380	400
2045 xxAM	0.7	0.6	4.5	5.0	5.9	7.2	7.8	8.5	8.7	9.3	9.8	10.0
2063 xxAM	1.0	0.8	6.3	7.0	8.3	10	10.9	11.8	12.2	13.0	13.7	14.1
2106 xxAM	1.5	1.2	10.6	11.9	14.2	16.8	18.4	19.8	20.5	21.8	23.1	23.7
2134 xxAM	1.8	1.4	13.4	15.0	17.7	21.2	23.2	25.0	25.9	27.6	29.2	29.9
2162 xxAM	2.0	1.5	16.2	18.1	21.4	25.6	28.0	30.3	31.4	33.4	35.3	36.2
2208 xxAM	2.1	1.8	20.8	23.3	27.5	32.9	36.0	38.9	40.2	42.9	45.3	46.5
2250 xxAM	2.5	1.9	25.0	28.0	33.0	39.5	43.3	46.8	48.4	51.6	54.5	55.9

### CONVERSION TABLE (UE - USA)

**PRESSURE: 1 bar = 14,5 psi**

**CAPACITY: 1 lpm = 0,264 gpm**

NUT	VAW MM 18 B1		
NIPPLE	ZWM 0035 B2		
STABILIZER	A	B	C
XHW MG20 T1	115	32	67

A = Complete Descaling unit Length (mm)  
B = Welding Nipple Length (mm)

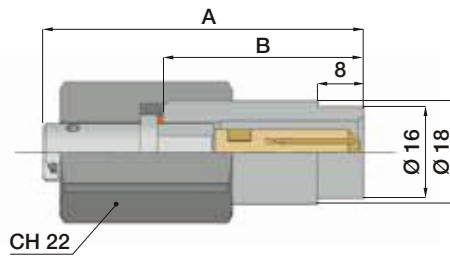

**WELDING NIPPLE**

Micro descaling nozzles can be assembled on the ZWM 0035 B2 nipple, 35 mm. long. PNR can supply on request a series of different length. The precision machined nipple inlet port assures precise positioning of the nozzle flat fan jet to the specified offset angle value of 15 ° with regard to the manifold centre line.

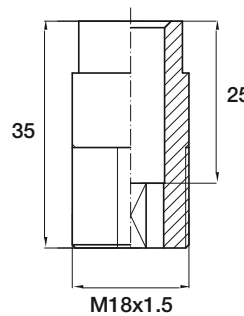

**MATERIALS**

<b>B2</b>	Stainless steel AISI 304		
<b>Code</b>	<b>RG</b> inch	<b>L</b> mm	<b>Weight</b> Kg
ZWM 0035 B2	1.5	35	0.20



**FLOW STABILIZER**

The flow stabilizer is a critical component for proper descaling, by reducing flow turbulence losses, a larger fraction of the water flow energy can be used for generating impact on the surface to be descaled. The design consists of a cylindrical brass body with a polished inner surface, housing a cast stainless steel flow stabilizer which straightens the liquid path to minimize turbulences.

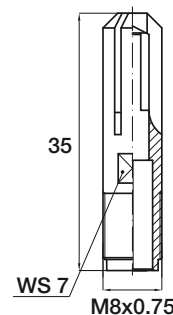

**MATERIALS**

<b>T1</b>	Brass		
<b>Code</b>	<b>L</b> mm	<b>Weight</b> Kg	<b>Notes</b>
XHW MG20 T1	35	0.04	with filter



**LOCKNUT**

The sturdy design and the generous dimensions of this locknut give the maximum protection to the nozzle and the nipple thread.

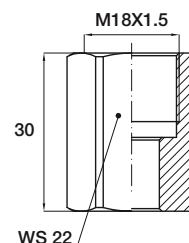

**MATERIALS**

<b>B1</b>	Stainless steel AISI 303		
<b>Code</b>	<b>Weight</b> Kg		
VAW MM18 B1	0.06		



**GASKET**

The VDA 10A5 T3 round gasket provides proper assembly and secure seal between nozzle and nipple.

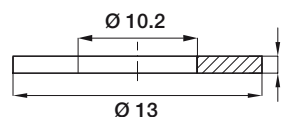

**MATERIALS**

<b>T3</b>	Copper	<b>Code</b> VDA 10A5 T3
-----------	--------	----------------------------



FLAT FAN JET NOZZLE

J type flat fan jet nozzles are used in the pickling process, a surface treatment used to remove impurities, such as discoloring oxide layers or scale on the surface, formed during hot working processes. These nozzles are available in a wide range of capacities, spray angles and materials. The tapered thread assures a tight connection and makes it easy to orient the jets in the desired direction. In case of "NPT" connection the model code changes from "J" to "H" but all other parts of the product ( thread, spray angle, material) remain unvaried.



SPRAY PATTERN

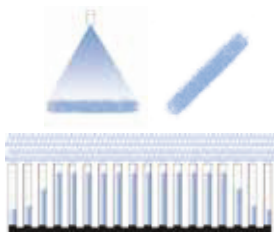

DIMENSIONS

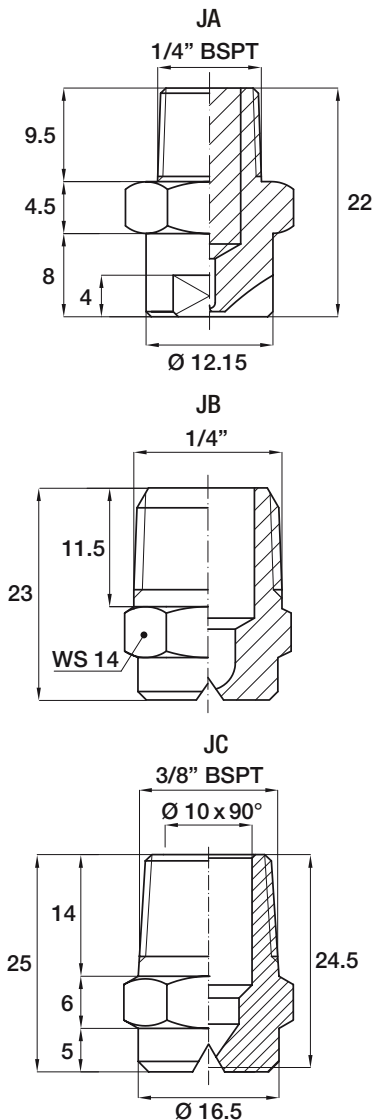

SPRAY ANGLE CODES

F	M	Q	U	W
30°	45°	60°	90°	120°

MATERIALS CODE

<b>B1</b>	Stainless steel AISI 303
<b>B31</b>	Stainless steel AISI 316L
<b>T1</b>	Brass
<b>D8</b>	PVDF

HOW TO ORDER PNR PRODUCTS

Model	Thread	Spray Angle	Capacity	Material
<b>J</b>	<b>A</b>	<b>C</b>	<b>2045</b>	<b>XX</b>

Order example: JAC 2045 B3

DIMENSIONS AND WEIGHTS

Model	Thread	Weight Kg		
		B1 / B31	T1	D8
<b>JA</b>	1/8"	0.010	0.011	0.002
<b>JB</b>	1/4"	0.020	0.021	0.003
<b>JC</b>	3/8"	0.024	0.028	0.004

30°	JAF	JBF	JCF	Code	Capacity - lpm								
					Pressure - bar								
					0.5	1.0	2.0	3.0	4.0	5.0	7.0	10	20
•				1190	0.78	1.10	1.55	1.90	2.19	2.45	2.90	3.47	4.91
•				1233	0.95	1.35	1.90	2.33	2.69	3.01	3.56	4.25	6.02
•	•			1310	1.27	1.79	2.53	3.10	3.58	4.00	4.74	5.66	8.00
•	•			1385	1.57	2.22	3.14	3.85	4.45	4.97	5.88	7.03	9.94
•	•			1490	2.00	2.83	4.00	4.90	5.66	6.33	7.48	8.95	12.6
•	•			1581	2.37	3.35	4.74	5.81	6.71	7.50	8.87	10.6	15.0
	•			1780	3.18	4.50	6.37	7.80	9.01	10.1	11.9	14.2	20.1
	•			1980	4.00	5.66	8.00	9.80	11.3	12.7	15.0	17.9	25.3
	•			2124	5.06	7.16	10.1	12.4	14.3	16.0	18.9	22.6	32.0
	•	•		2153	6.25	8.83	12.5	15.3	17.7	19.8	23.4	27.9	39.5
	•	•		2195	7.96	11.3	15.9	19.5	22.5	25.2	29.8	35.6	50.3
	•	•		2245	10.0	14.1	20.0	24.5	28.3	31.6	37.4	44.7	63.3
		•		2274	11.2	15.8	22.4	27.4	31.6	35.4	41.9	50.0	70.7
		•		2310	12.7	17.9	25.3	31.0	35.8	40.0	47.4	56.6	80.0
		•		2390	15.9	22.5	31.8	39.0	45.0	50.3	59.6	71.2	100.0
		•		2470	19.2	27.1	38.4	47.0	54.3	60.7	71.8	85.8	121.0

	JAM	JBM	JCM	Code	Capacity - lpm								
					Pressure - bar								
					0.5	1.0	2.0	3.0	4.0	5.0	7.0	10	20
45°	•			1190	0.78	1.10	1.55	1.90	2.19	2.45	2.90	3.47	4.91
	•			1233	0.95	1.35	1.90	2.33	2.69	3.01	3.56	4.25	6.02
	•	•		1310	1.27	1.79	2.53	3.10	3.58	4.00	4.74	5.66	8.00
	•	•		1385	1.57	2.22	3.14	3.85	4.45	4.97	5.88	7.03	9.94
	•	•		1490	2.00	2.83	4.00	4.90	5.66	6.33	7.48	8.95	12.6
	•	•		1581	2.37	3.35	4.74	5.81	6.71	7.50	8.87	10.6	15.0
		•		1780	3.18	4.50	6.37	7.80	9.01	10.1	11.9	14.2	20.1
		•	•	1980	4.00	5.66	8.00	9.80	11.3	12.7	15.0	17.9	25.3
		•	•	2124	5.06	7.16	10.1	12.4	14.3	16.0	18.9	22.6	32.0
		•	•	2153	6.25	8.83	12.5	15.3	17.7	19.8	23.4	27.9	39.5
		•	•	2195	7.96	11.3	15.9	19.5	22.5	25.2	29.8	35.6	50.3
		•	•	2245	10.0	14.1	20.0	24.5	28.3	31.6	37.4	44.7	63.3
			•	2274	11.2	15.8	22.4	27.4	31.6	35.4	41.9	50.0	70.7
			•	2310	12.7	17.9	25.3	31.0	35.8	40.0	47.4	56.6	80.0
			•	2390	15.9	22.5	31.8	39.0	45.0	50.3	59.6	71.2	100.0
		•	2470	19.2	27.1	38.4	47.0	54.3	60.7	71.8	85.8	121.0	

	JAQ	JBQ	JCQ	Code	Capacity - lpm								
					Pressure - bar								
					0.5	1.0	2.0	3.0	4.0	5.0	7.0	10	20
60°	•	•		1190	0.78	1.10	1.55	1.90	2.19	2.45	2.90	3.47	4.91
	•	•		1233	0.95	1.35	1.90	2.33	2.69	3.01	3.56	4.25	6.02
	•	•		1310	1.27	1.79	2.53	3.10	3.58	4.00	4.74	5.66	8.00
	•	•		1385	1.57	2.22	3.14	3.85	4.45	4.97	5.88	7.03	9.94
	•	•	•	1490	2.00	2.83	4.00	4.90	5.66	6.33	7.48	8.95	12.6
	•	•	•	1581	2.37	3.35	4.74	5.81	6.71	7.50	8.87	10.6	15.0
		•	•	1780	3.18	4.50	6.37	7.80	9.01	10.1	11.9	14.2	20.1
		•	•	1980	4.00	5.66	8.00	9.80	11.3	12.7	15.0	17.9	25.3
		•	•	2124	5.06	7.16	10.1	12.4	14.3	16.0	18.9	22.6	32.0
		•	•	2153	6.25	8.83	12.5	15.3	17.7	19.8	23.4	27.9	39.5
		•	•	2195	7.96	11.3	15.9	19.5	22.5	25.2	29.8	35.6	50.3
		•	•	2245	10.0	14.1	20.0	24.5	28.3	31.6	37.4	44.7	63.3
		•	•	2274	11.2	15.8	22.4	27.4	31.6	35.4	41.9	50.0	70.7
			•	2310	12.7	17.9	25.3	31.0	35.8	40.0	47.4	56.6	80.0
			•	2390	15.9	22.5	31.8	39.0	45.0	50.3	59.6	71.2	100.0
		•	2470	19.2	27.1	38.4	47.0	54.3	60.7	71.8	85.8	121.0	

### CONVERSION TABLE (UE - USA)

<b>PRESSURE: 1 bar = 14,5 psi</b>	<b>CAPACITY: 1 lpm = 0,264 gpm</b>
-----------------------------------	------------------------------------

▷ continued on page 56

	JAU	JBU	JCU	Code	Capacity - lpm								
					Pressure - bar								
					0.5	1.0	2.0	3.0	4.0	5.0	7.0	10	20
90°	•			1190	0.78	1.10	1.55	1.90	2.19	2.45	2.90	3.47	4.91
	•			1233	0.95	1.35	1.90	2.33	2.69	3.01	3.56	4.25	6.02
	•	•		1310	1.27	1.79	2.53	3.10	3.58	4.00	4.74	5.66	8.00
	•	•		1385	1.57	2.22	3.14	3.85	4.45	4.97	5.88	7.03	9.94
	•	•		1490	2.00	2.83	4.00	4.90	5.66	6.33	7.48	8.95	12.6
	•	•	•	1581	2.37	3.35	4.74	5.81	6.71	7.50	8.87	10.6	15.0
	•	•	•	1780	3.18	4.50	6.37	7.80	9.01	10.1	11.9	14.2	20.1
		•	•	1980	4.00	5.66	8.00	9.80	11.3	12.7	15.0	17.9	25.3
		•	•	2124	5.06	7.16	10.1	12.4	14.3	16.0	18.9	22.6	32.0
		•	•	2153	6.25	8.83	12.5	15.3	17.7	19.8	23.4	27.9	39.5
		•	•	2195	7.96	11.3	15.9	19.5	22.5	25.2	29.8	35.6	50.3
		•	•	2245	10.0	14.1	20.0	24.5	28.3	31.6	37.4	44.7	63.3
		•	•	2274	11.2	15.8	22.4	27.4	31.6	35.4	41.9	50.0	70.7
			•	2310	12.7	17.9	25.3	31.0	35.8	40.0	47.4	56.6	80.0
			•	2390	15.9	22.5	31.8	39.0	45.0	50.3	59.6	71.2	100.0
		•	2470	19.2	27.1	38.4	47.0	54.3	60.7	71.8	85.8	121.0	

	JAW	JBW	JCW	Code	Capacity - lpm								
					Pressure - bar								
					0.5	1.0	2.0	3.0	4.0	5.0	7.0	10	20
120°	•			1190	0.78	1.10	1.55	1.90	2.19	2.45	2.90	3.47	4.91
	•	•		1233	0.95	1.35	1.90	2.33	2.69	3.01	3.56	4.25	6.02
	•	•		1310	1.27	1.79	2.53	3.10	3.58	4.00	4.74	5.66	8.00
	•	•	•	1385	1.57	2.22	3.14	3.85	4.45	4.97	5.88	7.03	9.94
	•	•	•	1490	2.00	2.83	4.00	4.90	5.66	6.33	7.48	8.95	12.6
	•	•	•	1581	2.37	3.35	4.74	5.81	6.71	7.50	8.87	10.6	15.0
	•	•	•	1780	3.18	4.50	6.37	7.80	9.01	10.1	11.9	14.2	20.1
	•	•	•	1980	4.00	5.66	8.00	9.80	11.3	12.7	15.0	17.9	25.3
		•	•	2124	5.06	7.16	10.1	12.4	14.3	16.0	18.9	22.6	32.0
		•	•	2153	6.25	8.83	12.5	15.3	17.7	19.8	23.4	27.9	39.5
		•	•	2195	7.96	11.3	15.9	19.5	22.5	25.2	29.8	35.6	50.3
		•	•	2245	10.0	14.1	20.0	24.5	28.3	31.6	37.4	44.7	63.3
			•	2274	11.2	15.8	22.4	27.4	31.6	35.4	41.9	50.0	70.7
			•	2310	12.7	17.9	25.3	31.0	35.8	40.0	47.4	56.6	80.0
			•	2390	15.9	22.5	31.8	39.0	45.0	50.3	59.6	71.2	100.0
		•	2470	19.2	27.1	38.4	47.0	54.3	60.7	71.8	85.8	121.0	

**CONVERSION TABLE (UE - USA)**

**PRESSURE:** 1 bar = 14,5 psi

**CAPACITY:** 1 lpm = 0,264 gpm



**ROLL COOLING NOZZLE**

KYA type special flat fan jet nozzles are the best solution to cool forged steel rolls on continuous casting machines with high spray width values. The direction of the two jets is designed to obtain maximum cooling efficiency over a long reach.

**SPRAY PATTERN**

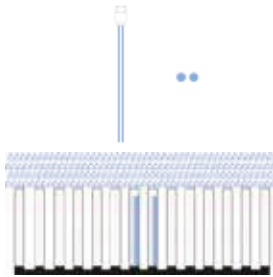

**MATERIALS**

<b>T1</b>	Brass
<b>B31</b>	Stainless steel AISI 316L

**HOW TO ORDER PNR PRODUCTS**

Model	Capacity	Material	Construction	Variation
<b>KYA</b>	<b>A</b>	<b>C</b>	<b>Y</b>	<b>Z</b>

Order example: **UEA D020 V7 SG**

**CONSTRUCTION: Y**

- **C** standard
- **L** long body

**VARIATION: Z**

- **A** metric thread M30x2
- **X** quick coupling

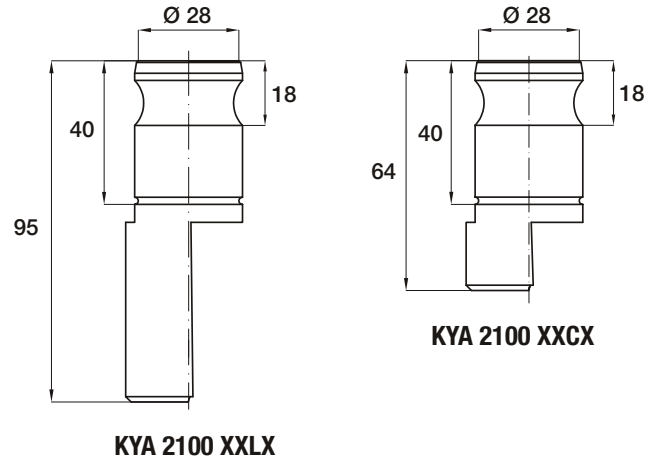
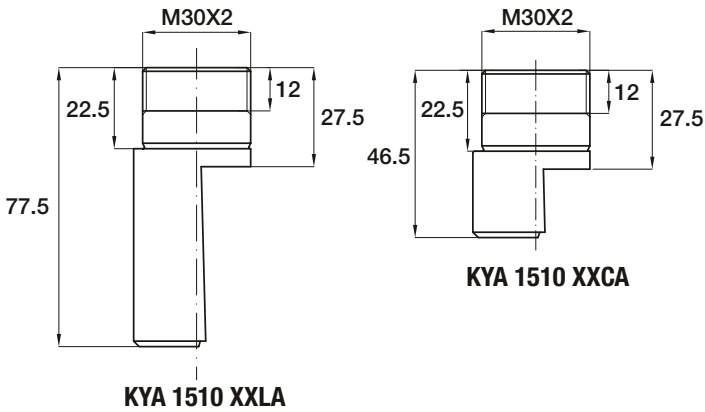

Code	Capacity - lpm								Weight	
	Pressure - bar								Kg	
	1.0	2.0	3.0	4.0	5.0	6.0	7.0	10.0	T1	B31
KYA 1510 xx	2.94	4.16	5.10	5.89	6.58	7.21	7.79	9.31	0,28	0,26
KYA 2107 xx	6.18	8.74	10.70	12.40	13.80	15.10	16.30	19.50	0,35	0,33

**CONVERSION TABLE (UE - USA)**

<b>PRESSURE: 1 bar = 14,5 psi</b>	<b>CAPACITY: 1 lpm = 0,264 gpm</b>
-----------------------------------	------------------------------------



**SPRAY PATTERN**



**DIMENSIONS**

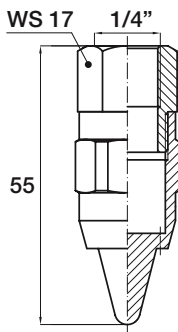

**AIR KNIFE COOLING SYSTEMS ROUND JET**

These efficient blow-off nozzles deliver a highly laminar stream of air with a powerful impact force. The laminar nature of the input air flow minimizes both the turbulence associated with the surrounding air that is entrained in the fast moving stream, and the level of audible noise produced. The body is made either of aluminium protected by a chemical nickel-plating coating, for applications requiring lightweight nozzles, or of stainless steel 316L for heavy duty. The table here below gives the values of air consumption at different operating pressures, whereas the graph shows the noise level as a function of location relative to the nozzle, measured at 2 bar.

**MATERIALS**

<b>V7</b>	Aluminium, chemical nickel-plating LT = 95 °C - LP = 15 bar
<b>B31</b>	Stainless steel AISI 316L LT = 110 °C - LP = 15 bar

LT: Maximum operating temperature

LP : Maximum operating pressure

**HOW TO ORDER PNR PRODUCTS**

Model	Version	Material	Construction	Variation
<b>UEA</b>	<b>D020</b>	<b>XX</b>	<b>Y</b>	<b>Z</b>

Order example: **UEA D020 V7SG**

**CONSTRUCTION: Y**

**VARIATION: Z**

- **S** standard (Female connection)
- **M** male Connection
- **G** cylindrical gas thread (BSPP)
- **N** conic gas thread

These air blowers meet the requirements of American OSHA regulation

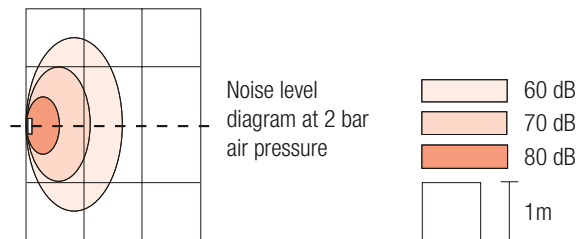

Code	RF inch	Capacity Air - Nm <sup>3</sup> /h					Weight Kg
		Pressure - bar					
		2.0	3.0	4.0	5.0	6.0	
UEA D020 B31xx	1/4	15	20	25	31	35	0.05
UEA D020 V7xx		15	20	25	31	35	0.03

**CONVERSION TABLE (UE - USA)**

<b>PRESSURE: 1 bar = 14,5 psi</b>	<b>CAPACITY: 1 Nm<sup>3</sup>/h = 0,59 cfm</b>
-----------------------------------	--



**AIR KNIFE COOLING SYSTEMS FLAT FAN JET**

These blow-off nozzles, containing multiple air channels, are used in applications where a flat fan jet of air with high impact velocity is required. Their design produces a uniform layer of air with low noise emission. Typical applications include cooling, drying, cleaning, and the movement of objects on a conveyor belt. The nozzles can be ganged together or on a pipe manifold to achieve wide coverage.

**SPRAY PATTERN**



**DIMENSIONS**

VERSION IN E31

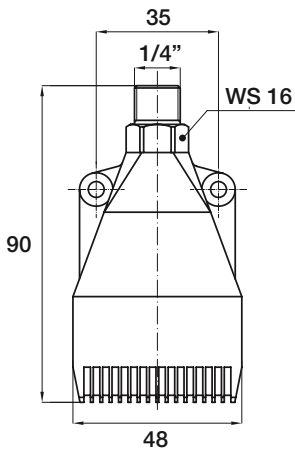

VERSION IN V7

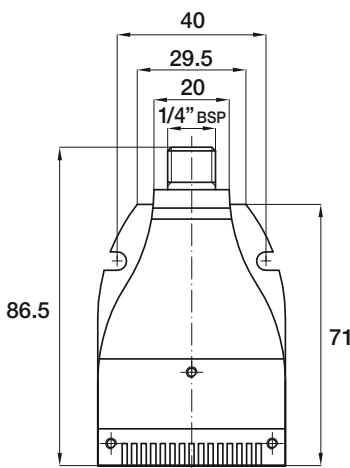

**MATERIALS**

<b>E31</b>	Polyacetal Resin (POM) LT = 80 °C - LP = 5 bar
<b>V7</b>	Aluminium, chemical nickel-plated LT = 95 °C - LP = 15 bar

LT: Maximum operating temperature

LP : Maximum operating pressure

**HOW TO ORDER PNR PRODUCTS**

Model	Version	Material	Construction	Variation
<b>UEA</b>	<b>L022</b>	<b>XX</b>	<b>Y</b>	<b>Z</b>

Order example: **UEA L022 V7SG**

**CONSTRUCTION: Y**

- **S** standard

**VARIATION: Z**

- **G** cylindrical gas thread (BSPP)
- **N** conic gas thread

These air blowers meet the requirements of American OSHA regulation

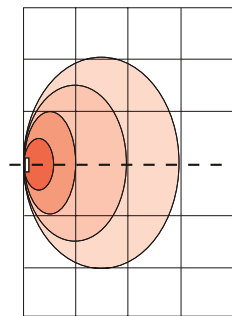

Noise level diagram at 3 bar air pressure

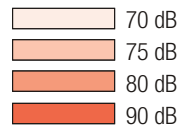

1m

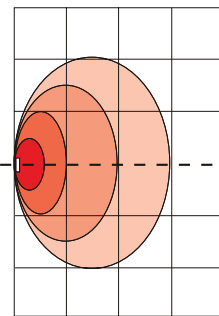

Noise level diagram at 8 bar air pressure

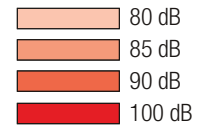

1m

See list of abbreviations - legenda at page 3.

Code	RG inch	Capacity Air - Nm <sup>3</sup> /h					Weight Kg
		Pressure - bar					
		1.0	2.0	3.0	4.0	5.0	
UEA L022 E31xx	1/4	10	17	22	28	33	0.03
UEA L022 V7xx	1/4	10	17	22	28	33	0.07

**CONVERSION TABLE (UE - USA)**

<b>PRESSURE: 1 bar = 14,5 psi</b>	<b>CAPACITY: 1 Nm<sup>3</sup>/h = 0,59 cfm</b>
-----------------------------------	--

**AIR KNIFE COOLING SYSTEMS BAR BLOWERS**

UEB air knives, used for rolls cooling, deliver a laminar flow of compressed air along their entire length with a powerful impact force, low speed and reduced noise level. Their particular design, based on the Coanda effect, allows to place the outlet orifice in a safe position and protect it from any possible damage.

UEB Air knives are manufactured in four different standard lengths and can be ganged together to create air barriers of any desired length.

The jet flow leaving the nozzle orifice curves away following the radiused profile and leaves the body of the air knife with a 90° angle from the initial jet direction, as shown in the drawing. This feature allows to place the nozzle orifice in a totally safe position thus making these air knives the perfect choice to use on conveyor belts, where the products being conveyed may oscillate and damage an ordinary blow-off system.

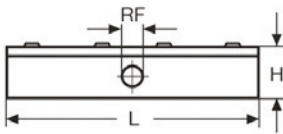
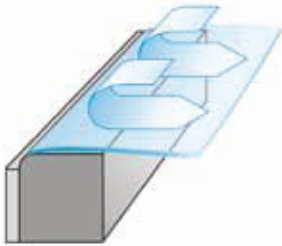

**UEB 0150 / UEB 0300**

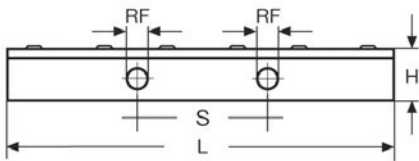

**UEB 0450 / UEB 0600**

The table below shows the air capacity as a function of the air pressure, whereas the graphs show the noise level as a function of the front and side distances from the nozzle, at an operating air pressure of 2 bar. As the air exiting the nozzle orifice drags along ambient air, the air blade produced by the nozzle (AIR OUT) has a higher flow rate which is a multiple of the entering air flow (AIR IN).

**MATERIALS**

<b>B31</b>	Body and upper plate	Stainless steel AISI 316 LT = 110 °C - LP = 7 bar
	Body	Aluminium, chemical nickel-plated
<b>V7</b>	Upper plate	Nickel plated steel LT = 95 °C - LP = 7 bar

LT: Maximum operating temperature

LP : Maximum operating pressure

**HOW TO ORDER PNR PRODUCTS**

Model	Length	Material	Construction	Variation
<b>UEB</b>	<b>150</b>	<b>XX</b>	<b>Y</b>	<b>Z</b>

Order example: **UEB 0150 V7SG**

**CONSTRUCTION: Y**

- **S** standard

**VARIATION: Z**

- **G** cylindrical gas thread (BSPP)
- **N** conic gas thread (NPT)

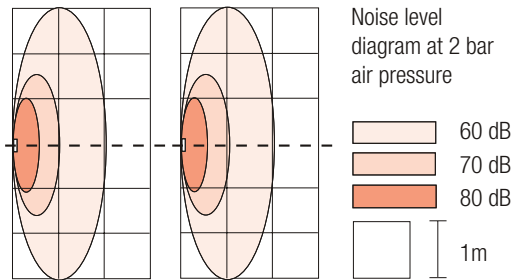

**UEB 0150**

**UEB 0300**

Code	RF inch	Capacity Air - Nm <sup>3</sup> /h										Dimensions mm			Weight kg
		Pressure - bar										H	L	S	
		2.0		3.0		4.0		5.0		6.0					
Al	AO	Al	AO	Al	AO	Al	AO	Al	AO	Al	AO				
UEB 0150 V7xx	1/4	0.26	4.7	0.34	6	0.42	7.1	0.51	8.6	0.6	10.6	30	150	-	0.30
UEB 0300 V7xx		0.52	9.4	0.68	12	0.84	14.2	1.02	17.2	1.2	21.2		300	-	0.70
UEB 0450 V7xx		0.78	14.1	1.03	18	12.6	21.3	1.53	25.8	1.8	31.8		450	270	0.90
UEB 0600 V7xx		1.03	18.7	1.4	24	1.68	28.4	2.04	34.4	2.4	42.4		600	300	1.40

**CONVERSION TABLE (UE - USA)**

<b>PRESSURE: 1 bar = 14,5 psi</b>	<b>CAPACITY: 1 Nm<sup>3</sup>/h = 0,59 cfm</b>
-----------------------------------	--

In addition to the general purpose spray nozzles found in this catalogue, PNR manufactures a wide range of other products and systems for liquid flow and fluid control; suitable for most modern industrial processes. These high quality products can be found in the following catalogues:



**CTG AC BR**  
**Accessories Catalogue**

A complete range of nipples, clamps, swivel joints and everything that helps you to easily assemble, align and service your spraying systems. Air blowers, mixing eductors, filters, cleaning guns and lances, hose reels, steam heaters, pressure tanks, quick couplings and more.

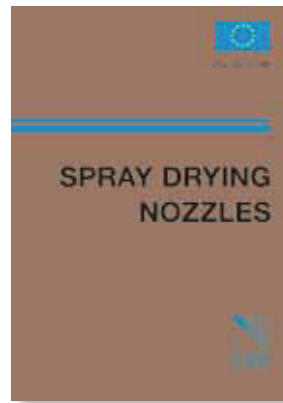

**CTG SP BR**  
**Spray drying nozzles**

High pressure or air assisted precision nozzles manufactured with top quality stainless steel housings and tungsten carbide internals. A complete line of nozzles to retrofit existing plants at competitive prices. Only the highest quality materials and the most precise machining are employed in the manufacture of our nozzles, to assure accurate results and consistent wear.

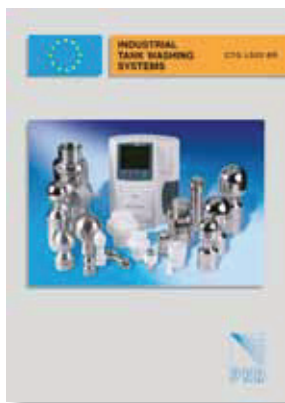

**CTG LS BR**  
**Tank washing systems**

Everything from the simple fixed sprayballs and pindle nozzles to the twin-axis wash heads. Reaction driven, water driven and electric or pneumatic motor driven. Professional inside surface cleaning of industrial tanks with the latest technology, together with state of the art accessories.

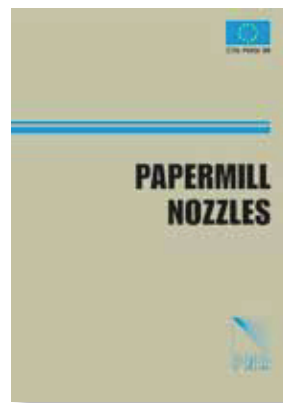

**CTG PM BR**  
**Papermill products**

A sixteen page catalogue showing products specifically developed for use on paper making machines, and paper mill processes. These include our patented disc nozzle for self-cleaning pipes, needle nozzles with sapphire and ruby orifices and oscillating pipes.



**CTG AZ BR**  
**Air assisted atomizers**

Ultrasonic, classic and automatic atomisers for the finest atomisation in any process. High quality machining and tight quality control assure a professional result for your system. Control cabinets aid easy construction of complete humidification systems.

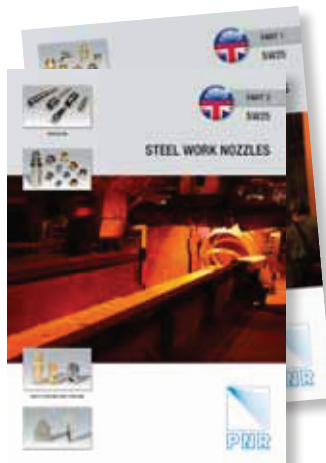

**CTG SW BR**  
**Steelwork nozzles**

A complete range of nozzles for steelwork applications, including continuous casting air atomisers and conventional nozzles, descaling nozzles for high pressure systems, fixed position dovetail tips and coke quenching high capacity flanged nozzles to name a few.



**CTG LN BR**  
**Gas cooling lances**

Spillback or air assisted lances for gas cooling processes in steelworks, cement plants and other industrial applications. We can supply spare parts, retrofit your system or even supply a complete system, PLC driven, to upgrade tower performances to the latest technical standards



**CTG FF BR**  
**Fire fighting products**

Everything for fixed and mobile foam systems, bladder tanks, any kind of foam mixer, monitors, foam lances and foam nozzles, mobile trailers for foam systems, pressure water nozzles, water mist nozzles and hydrants.



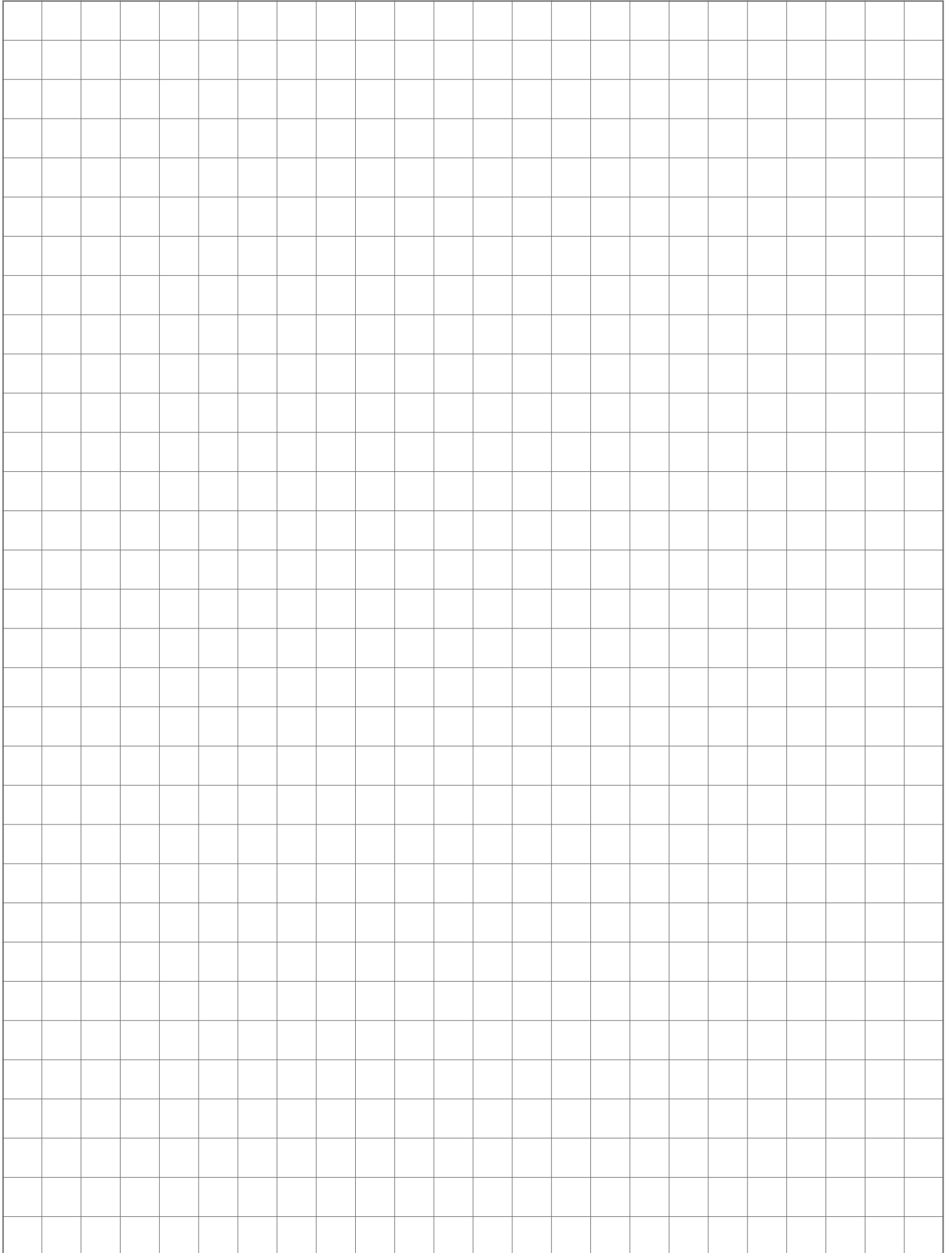



# A GLOBAL PRESENCE ALL OVER THE WORLD.

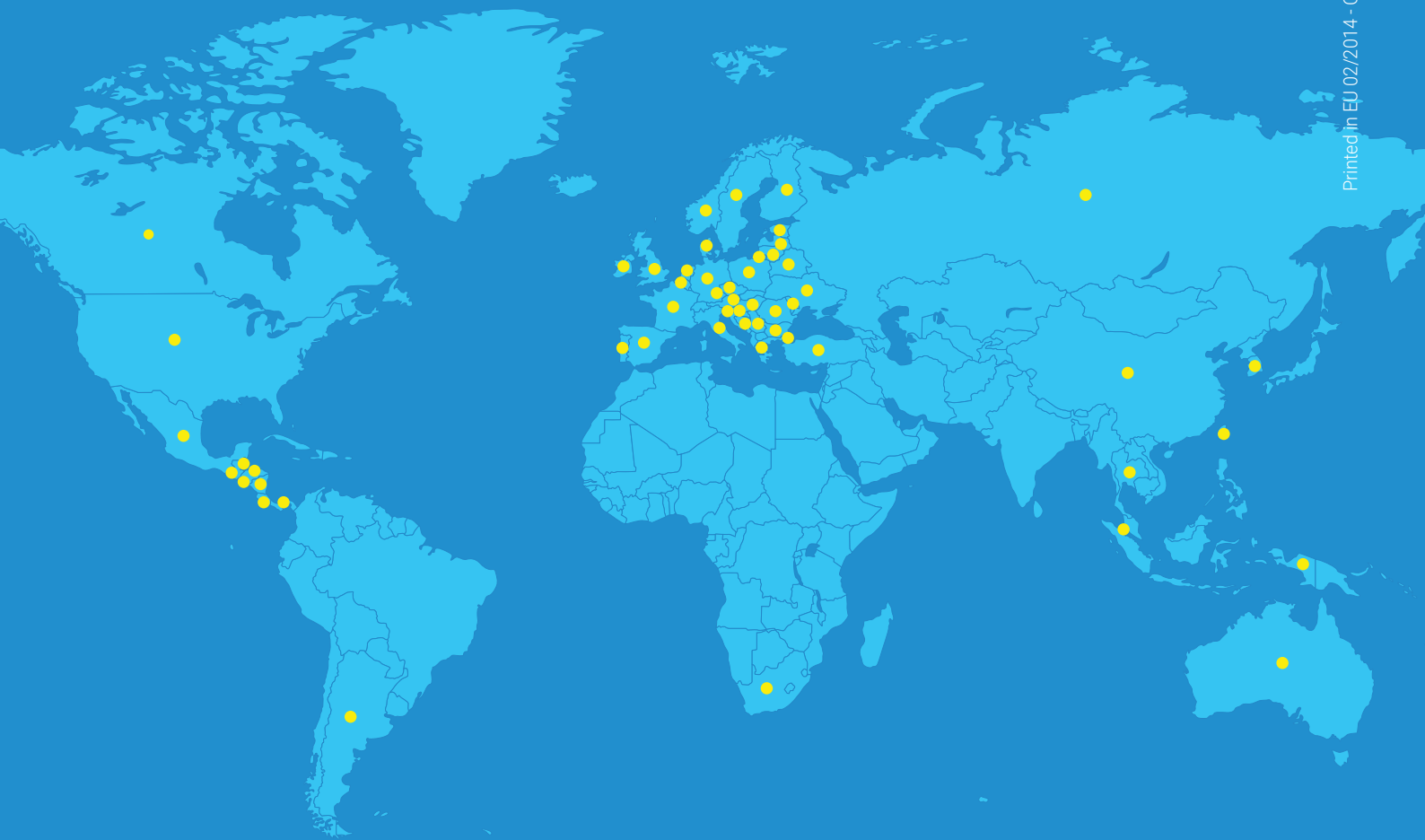

Printed in EU 02/2014 - CTG SW2 EN - ©PNR Italia, all rights reserved



## HEADQUARTERS:

PNR Italia srl Via Nenni/Gandini 27058 Voghera (PV) Italia

Phone +39 0383 344 611 Fax +39 0383 212 489

Email [info@pnr.it](mailto:info@pnr.it) For more info, visit [www.pnr.eu](http://www.pnr.eu)

