

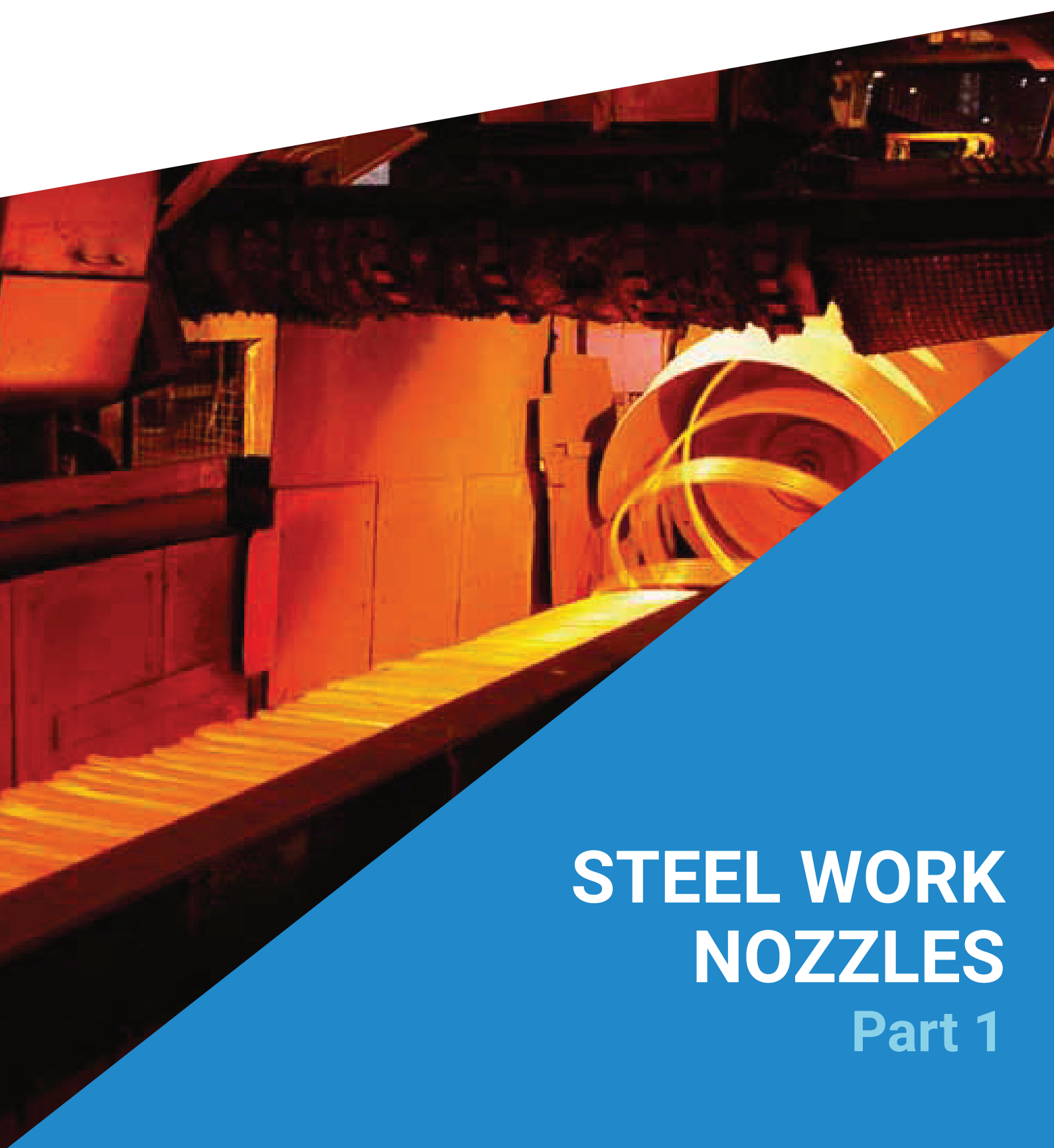

SPRAY NOZZLES FOR INDUSTRIAL APPLICATIONS



STEEL WORK NOZZLES

Part 1



PNR designs and manufactures high quality spraying nozzles and fluids handling systems. Our range includes a great variety of nozzles that have been successfully used for over 40 years in virtually every manufacturing and processing industry.

We offer a complete range of nozzle types, spray patterns, droplet sizes and capacities made in top quality materials to suit every application, but we also design and produce special nozzles to meet customers' specific needs.

To the steel industry in particular we offer a wide range of products for the whole steelmaking process:

- nozzles for dust suppression on raw materials parks and emission control
- nozzles for coke suppression and cooling
- nozzles for continuous casting cooling and cold lamination (water + air/water)
- high pressure descaling spray nozzles,
- nozzles for roll cooling and pickling
- etc.

a comprehensive range completed by several accessory products and components, available in many different types, sizes and materials.

PNR Italia Srl is an ISO 9001:2015 accredited company.

The full range of **PNR** is shown in our catalogues which can be requested in hard copy or downloaded from our website www.pnr.eu

Reference Library

CTG AC	Accessories
CTG AZ	Air assisted atomizing nozzles
CTG FF	Fire Fighting Systems and Products
CTG LN	Cooling Lances
CTG LS	Tank cleaning systems
CTG PM	Nozzles for pulp & paper mills
CTG SP	Spray-drying nozzles
CTG SW	Steelworks nozzles

Our products are marketed worldwide by PNR companies, with offices in Russia, USA, Benelux, China, Germany, Mexico, France, United Kingdom, Sweden, as well as by a capillary network of distributors in many other Countries.

Our products are continuously being reviewed and modified to keep up with the latest technology. As a result the technical information provided in this catalogue is for guidance only and is not binding. Should you have an application that requires special features (specific flow rates, spray angles, etc.) please contact our sales office to find the best solution to meet your requirements.

PRODUCT IDENTIFICATION

PNR CODING SYSTEM

Every industrial product needs to be identified with a code to avoid mistakes.

PNR product coding system was conceived to meet the following requirements:

- codes are easily listed by a computer in alphabetical order.
- codes fully describe the product, with no need of further information.
- codes immediately provide the main characteristics of each product so to find it in the catalogue easily.

Code Definition is as follows:

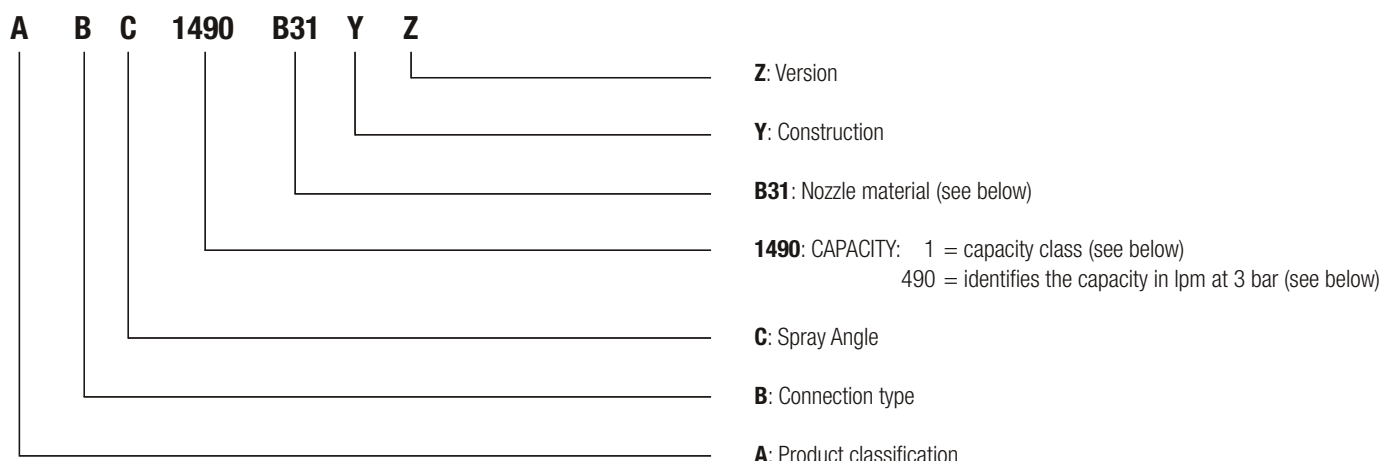

Flow rate capacity at 3 bar.

These codes are purely indicative, their meaning may be occasionally different. Please always refer to the numeric indication of the angles beside each table.

CAPACITY CLASS

Class	Numbers	Capacity in lpm
0	0 490	0,49
1	1 490	4,90
2	2 490	49,0
3	3 490	490
4	4 490	4900

COMMON SPRAY ANGLES

A = 0°	L = 40°	T = 80°
B = 15°	M = 45°	U = 90°
C = 20°	N = 50°	J = 110°
D = 25°	Q = 60°	W = 120°
F = 30°	R = 65°	Y = 130°
H = 35°	S = 75°	Z = 180°

PNR PRODUCTS MATERIALS CODE

A1	Carbon Steel
A8	Zinc plated carbon steel
A9	Nickel plated carbon steel
B1	Stainless steel AISI 303
B2	Stainless steel AISI 304
B21	Stainless steel AISI 304 L
B31	Stainless steel AISI 316L
C1	Stainless steel AISI 420 hardened
C2	Stainless steel AISI 416 hardened
D1	Polyvinyl chloride (PVC)
D2	Polypropylene (PP)
D3	Polyamide (PA)
D5	Talc filled Polypropylene

D6	Glass fiber reinforced polypropylene
D7	High-density polyethylene (HDPE)
D8	Polyvinylidene fluoride (PVDF)
E0	Ethylene-propylene diene monomer (EPDM)
E1	Polytetrafluorethylene (PTFE)
E14	25% glass fiber filled PTFE
E3	Polyoxymethylene (POM)
E7	Fluoroelastomer polymer Viton® (FPM)
E8	Nitrile butadiene rubber (NBR)
F1	Tungsten carbide
F3	Ruby
F5	Ceramic

G1	Grey cast iron
H1	Titanium
L1	Nickel alloy Monel® 400
L2	Nickel alloy Incolloy® 825
L8	Nickel alloy Hastelloy® C276
T1	Brass
T2	Chrome plated brass
T3	Copper
T5	Bronze
T8	Galvanic nickel plated brass
T81	Electroless nickel plated brass
V1	Aluminum alloy
V7	Electroless nickel plated aluminum alloy

LIST OF ABBREVIATIONS - LEGENDA

AE	Inlet air capacity	Nmc/min
AU	Outlet air capacity	Nmc/min
CL	Spray jet deflection angle	degrees
D	For round exit hole: hole diameter For not round exit holes: equivalent round hole diameter	mm
D1	Smallest passage diameter	mm
DE	Liquid inlet diameter	mm
DF	Flange nominal size for ANSI/ASME flanges	inch
DIA	Outer diameter	mm
DN	Flange nominal size for UNI/DIN flanges	mm
DU	Liquid outlet diameter	mm
DX	Nipple inner diameter	mm
FF	Flange outer diameter	mm
G	Diameter measured between fixing holes centers	mm
H, H1, H2	Height	mm

L, L1	Length	mm
LF	Pipe length	m
LP	Maximum operating pressure	bar
LQ	Maximum capacity	lpm
LT	Maximum operating temperature	°C
NR	Number of orifices	-
QC	Quick coupling connection	-
RA	Radius	mm
RF	Parallel female thread BSPP	inch
RG	Tapered male thread BSPT	inch
S	Thickness	mm
SQ	Square bar size	mm
W	Weight	g, Kg
WS	Wrench size	mm

PRODUCT WARRANTY

PNR products will be replaced or repaired at the discretion of PNR and free of charges should the product be found to be defective in manufacturing, labelling or packaging. The product warranty applies for 1 year from the date of shipment. Please note that this will only apply if the problem is reported to PNR within 30 days from the date of shipment. The cost of rectification or repair and procedure to replace products will only apply if these terms are adhered to. Any breach of the warranty conditions will contravene our terms. PNR shall not be held liable for any damage, personal injuries or commercial losses which might be caused by product malfunction.

Should you need to report a defect, our Company Procedure for warranty is as follows:

- 1 Please contact the nearest PNR or PNR Distributor and obtain a return authorization number.
- 2 Please return the products according to PNR instructions, should you be authorized to return the products.
- 3 PNR shall then issue a test report, send you a copy and return the product repaired or replaced.

Our company ethos is to offer full customer satisfaction and we are fully aware of the inconvenience which might be caused from a defective product. Please be assured that we shall do our utmost to offer a solution in the shortest possible time.

PRODUCT RETURN POLICY

WRONG PRODUCTS DELIVERED BY PNR

- 1 Please Contact nearest PNR or PNR distributor and obtain a return authorization number.
- 2 PNR will sustain the expenses for transport.
- 3 Please agree with your PNR contact if PNR shall have to issue a credit note or make a product replacement.

MISTAKES IN ORDERS SENT TO PNR

- 1 Please Contact nearest PNR or PNR distributor and obtain a return authorization number.
- 2 Please return the products according to PNR instructions.
- 3 The products will be returned at your expense.
- 4 Products must be returned in their original condition and inside the original packaging, or equivalent quality packaging
- 5 A re-stocking charge of between 10% and 25% may also apply. Such decision will be communicated by contacted PNR or PNR distributor.

NON CATALOG PRODUCTS

These products can only be returned after a written authorization from PNR has been obtained.

DISCLAIMER

Our products are manufactured with the best care and according to the latest developments of the technology, but we cannot assure that every one of our products is perfectly fit for any possible specific process. The information in this Catalogue is provided "as is" and we make no warranty of any kind with respect to the subject matter or accuracy of the information contained herein. This publication may include technical inaccuracies or typographical errors and changes may be periodically made to the information herein without prior notice.

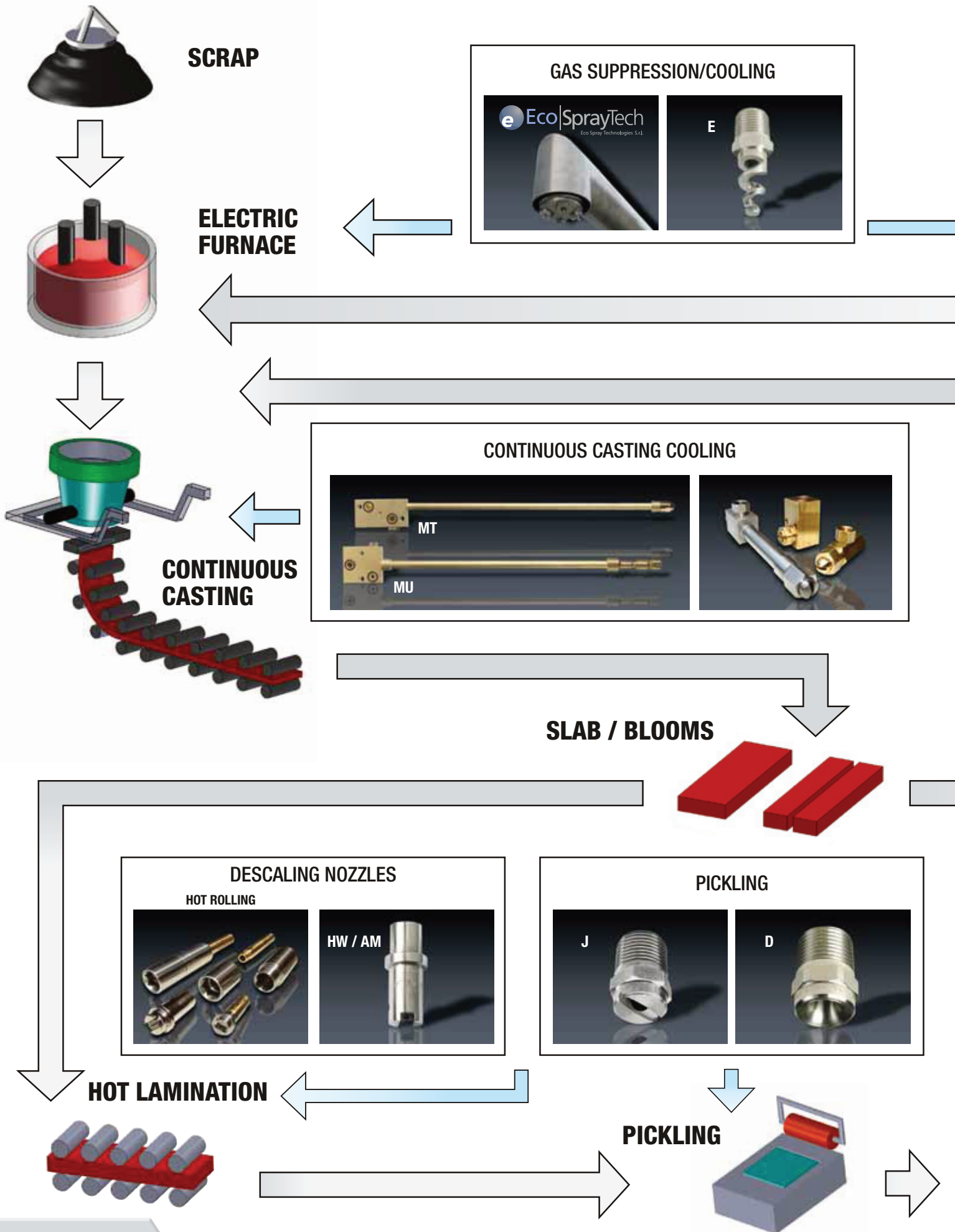

DUST SUPPRESSION ON RAW MATERIALS PARK

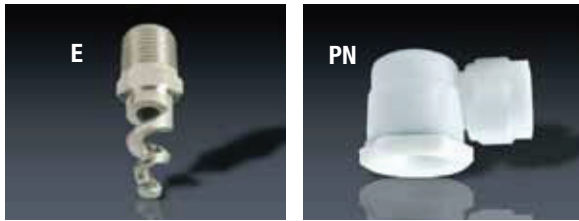

RAW MATERIALS



BASIC OXIGEN CONVERTER



BLAST FURNACE

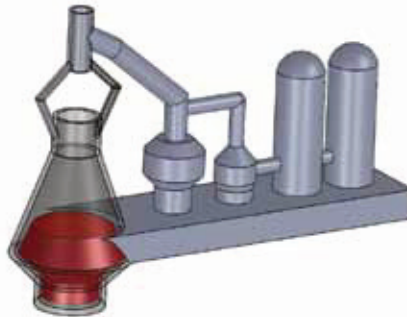

COKE COOLING



COLD LAMINATION

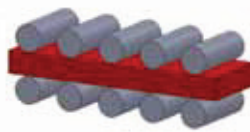

COILS



ROLLS COOLING



COLD LAMINATION

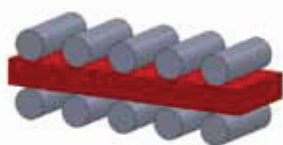

ANNEALING



TEMPER

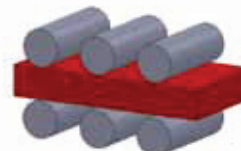

COILS



	Page	
ISO 9001:2014 CERTIFICATION	1	
PRODUCT IDENTIFICATION	2	
GENERAL INFORMATION	3	
NOZZLES IN STEELWORKS	4	
<hr/>		
DUST SUPPRESSION ON RAW MATERIALS PARK		
- Model "E" - Spiral shape cone nozzle	8	  
- Model "K" - Fan jet nozzle	10	
- Model "PN/PO" - Hollow cone nozzle	12	
<hr/>		
COKE SUPPRESSION / COOLING		
- Model "AE" - Full cone nozzle	14	  
- Model "BE" - Full cone nozzle	15	
- Model "PR" - Hollow cone nozzle	16	
<hr/>		
CONTINUOUS CASTING COOLING (WATER)		
- Model "AH" - Full cone nozzles/disc vane	18	  
- Model "BA/BC" - Full cone nozzles	19	
- Model "D" - Full cone nozzles	20	  
- Model "BX" - Full cone nozzle tips	23	
- Model "D..OB" - Oval jet nozzles	24	 
- Model "D..PB" - Oval jet nozzles	25	
- Model "BH" - Full cone nozzles	26	
- Model "926" - Rectangular jet nozzle tips	27	
<hr/>		
COLD ROLLING		
- Model "GX" - Fan jet nozzle tips	28	  
- Model "GY" - Fan jet nozzle tips with dove tail	30	
- Model "F" - Fan jet nozzle	32	

DESCALING

Page

PRINCIPLES, NOZZLES FEATURE, IMPACT MEASUREMENT 38

- Model "GW" - Dove-tail nozzle 40
- Model "HW/AH" - Short nozzle, standard size 42
- Model "HW/AA" - Short nozzle, mini size 44
- Model "HW/AK" - High impact nozzle - Standard Size 46
- Model "HW/AB" - High impact nozzle - Mini Size 48
- Model "HV/AH" - High impact nozzle - Special Size 50
- Model "HV/AM" - High impact nozzle - Micro Size 52



PICKLING

- Model "J" - Fan jet nozzle 54



ROLLS COOLING

- Model "KYA" - Rolls cooling nozzles 57
- Model "UEA D020" - Compressed air blower 58
- Model "UEA L022" - Compressed air blower 59
- Model "UEB" - Compressed air blower 60



We regret not being able to update our customers on the continuous improvements to our product range, so please consider the information and product specifications supplied in this catalogue as indicative and not binding for our company. For each application that requires one or more characteristics of one of our catalogue products that must be strictly maintained, please kindly ask for a written confirmation. Any information contained in this Catalogue, codes and product specifications, sketches, drawings and photographs, is the exclusive property of Flowtech Srl and it is forbidden to reproduce it in any medium without express written permission of the same.

All dimensions in this catalogue are in millimetres (mm). All threads to be manufactured according to ISO 228 unless otherwise specified. (European Standard BS 2779 - DIN 259 - UNI 338).

All trademarks mentioned in this catalogue are owned by their respective owners.



STANDARD SPIRAL NOZZLES

E series spiral nozzles work on the impact principle, by the deflection of a water stream that impacts onto a spiral-shaped surface providing the desired spray angle. These are one-piece nozzles with no internal vane and a wider free passage. The liquid inlet has nearly the same size as the outlet orifice diameter. Their special design minimizes clogging and produces a wider spray coverage than other nozzles with a given flow and pressure. The capacity value on darker background can be obtained with metal nozzles only as plastic nozzles cannot ensure resistance in harsh operating conditions. If the capacity values you are looking for are those in bold letters, we recommend to choose metal nozzles for their longer operating life.

SPRAY DISTRIBUTION

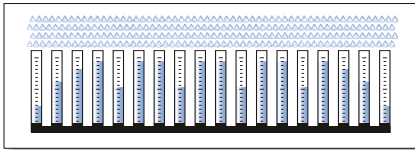

Spiral-shaped distribution

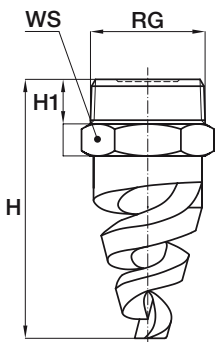

SPRAY ANGLE CODE

Q	60°
U	90°
W	120°

THREAD CODE

B	1/4"
C	3/8"
D	1/2"
E	3/4"
F	1"
H	1 1/2"
K	2"
M	3"
P	4"

MATERIALS CODE

B31	Stainless steel AISI 316L
D1	PVC
D2	Polypropylene
D8	PVDF
E1	PTFE
L8	Hastelloy C 276
T1	Brass

SPRAY PATTERN

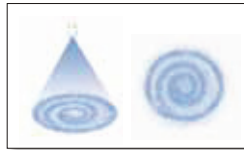

CONSTRUCTION: Y

- **S** Standard

VERSION: Z

- **B** Tapered thread (BSPT- EN 10226)
- **G** Parallel thread (BSPP- EN 10226)
- **N** Tapered thread (NPT-ANSI B 1.20)

HOW TO ORDER PNR PRODUCTS

Model	Thread	Spray Angle	Capacity	Material	Construction	Version
E	B	Q	1550	XX	Y	Z

Order example: **EBQ 1550 B31 SB**

CAPACITY - DIMENSIONS AND WEIGHTS

Code	RG	D	D1	Capacity - lpm								Dimensions mm			Weight g		
				Pressure - bar								H	H1	WS	B31	Plastic	Brass
				0,7	1,0	2,0	3,0	5,0	7,0	10							
60°	EBQ 1550 xx	1/4	2,4	2,4	2,66	3,18	4,49	5,50	7,10	8,40	10,0	45	12	14	22	6	26
	EBQ 2156 xx		4,0	3,2	7,54	9,01	12,7	15,6	20,1	23,8	28,5						
	ECQ 2230 xx	3/8	4,8	3,2	11,4	13,6	19,2	23,5	30,3	35,9	42,9	48	14	19	43	11	48
	ECQ 2410 xx		6,4	3,2	20,0	24,0	33,9	41,5	53,6	63,4	75,8						
	ECQ 2640 xx		7,9	3,2	31,2	37,3	52,7	64,6	83,4	99,0	118						
	EDQ 2940 xx	1/2	9,5	4,7	45,6	54,5	77,1	94,4	122	144	172	64	18	22	79	10	81
	EDQ 3128 xx		11,1	4,7	61,8	73,9	105	128	165	196	234						
	EEQ 3165 xx	3/4	12,7	4,7	79,7	95,3	135	165	213	252	301	70	19	27	136	16	141
	EFQ 3260 xx	1	15,9	6,3	126	150	212	260	336	397	475	92	26	34	254	50	289
	EHQ 3507 xx	1 1/2	22,2	7,9	245	293	414	507	655	774	926	111	27	50	619	150	768

TYPICAL APPLICATIONS

- Gas Cooling

DUST SUPPRESSION ON RAW MATERIAL PARKS

- Exhaust scrubbers
- Desulfurization

CONVERSION TABLE (UE - USA)

PRESSURE: 1 bar = 14,5 psi

CAPACITY: 1 lpm = 0,264 gpm

	Code	RG	D	D1	Capacity - lpm							Dimensions mm			Weight g		
					Pressure - bar							H	H1	WS	B31	Plastic	Brass
		inch	mm	mm	0,7	1,0	2,0	3,0	5,0	7,0	10						
90°	EBU 1550 xx	1/4	2,4	2,4	2,66	3,18	4,49	5,50	7,10	8,40	10,0	45	12	14	22	6	26
	EBU 2100 xx		3,2	3,2	4,83	5,77	8,16	10,0	12,9	15,3	18,3						
	EBU 2156 xx		4,0	3,2	7,54	9,01	12,7	15,6	20,1	23,8	28,5						
	ECU 2230 xx	3/8	4,8	3,2	11,4	13,6	19,2	23,5	30,3	35,9	42,9	48	14	19	43	11	48
	ECU 2317 xx		5,6	3,9	15,3	18,3	25,9	31,7	40,9	48,4	57,9						
	ECU 2410 xx		6,4	4,8	20,0	24,0	33,9	41,5	53,6	63,4	75,8						
	ECU 2640 xx	1/2	7,9	5,5	31,2	37,3	52,7	64,6	83,4	98,7	118	64	18	22	79	10	81
	EDU 2940 xx		9,5	3,3	45,6	54,5	77,1	94,4	122	144	172						
	EDU 3128 xx	11,1	3,7	61,8	73,9	105	128	165	196	234	70	19	27	136	16	141	
	EEU 3165 xx	3/4	12,7	4,7	79,7	95,3	135	165	213	252							301
	EFU 3260 xx	1	19,0	6,3	126	150	212	260	336	397	475	92	26	34	254	50	288
	EFU 3372 xx		23,0	6,3	180	215	304	372	480	568	679						
	EKU 4100 xx	2	34,9	11,1	527	629	890	1090	1407	1665	1990	149	31	65	1300	380	1400
	EMU 4204 xx	3	44,5	14,3	985	1178	1666	2040	2634	3116	3725	219	42	89	3200	400	4000
EMU 4267 xx	50,8		1290		1542	2180	2670	3447	4078	4875							
120°	EBW 1550 xx	1/4	2,4	2,4	2,66	3,18	4,49	5,50	7,10	8,40	10,0	45	12	14	22	6	26
	EBW 2100 xx		3,2	3,2	4,83	5,77	8,16	10,0	12,9	15,3	18,3						
	EBW 2156 xx		4,0	3,2	7,54	9,01	12,7	15,6	20,1	23,8	28,5						
	ECW 2156 xx	3/8	4,0	3,2	7,54	7,54	7,5	15,6	20,1	23,8	28,5	48	14	19	43	11	48
	ECW 2230 xx		4,8	3,2	11,4	13,6	19,2	23,5	30,3	35,9	42,9						
	ECW 2317 xx		5,6	4,0	15,3	18,3	25,9	31,7	40,9	48,4	57,9						
	ECW 2410 xx	6,4	4,0	20,0	24,0	33,9	41,5	53,6	63,4	75,8	64	18	22	79	10	81	
	ECW 2640 xx	7,9	4,0	31,2	37,3	52,7	64,6	83,4	98,7	118							
	EDW 2940 xx	1/2	9,5	4,8	45,6	54,5	77,1	94,4	122	144	172	70	19	27	136	16	141
	EDW 3104 xx		9,7	4,8	50,2	60,0	84,9	104	134	159	190						
	EDW 3128 xx		11,1	4,8	61,8	73,9	105	128	165	196	234						
	EEW 3165 xx	3/4	12,7	4,8	79,7	95,3	135	165	213	252	301	92	26	34	254	50	289
	EFW 3260 xx	1	15,9	6,3	126	150	212	260	336	397	475						
	EFW 3372 xx	19,0	180		215	304	372	480	568	679	111	27	50	619	150	768	
	EHW 3507 xx	1 1/2	22,2	7,9	245	293	414	507	655	774							926
	EHW 3663 xx		25,4		320	383	541	663	856	1013							1210
	EHW 3747 xx		28,6		361	431	610	747	964	1141	1364						
	EKW 4100 xx	2	34,9	11,1	527	629	890	1090	1407	1665	1990	149	31	65	1300	380	1400
	EKW 4139 xx		38,1		672	803	1136	1391	1796	2125	2540						
	EMW 4204 xx	3	44,5	14,3	985	1178	1666	2040	2634	3116	3725	203	35	90	3200	400	4000
	EMW 4267 xx		51,0		1280	1530	2164	2650	3421	4048	4838						
	EPW 4412 xx	4	63,5	15,9	1990	2379	3364	4120	5319	6293	7522	230	40	127	6800	900	7800

LARGE SPRAY ANGLE

K flat jet nozzles work on the deflection principle conveying a water vein onto a machined deflection surface and produce a jet with a wide angle flat spray pattern, medium impact value and medium size droplets. Between their inlet orifice and spray orientation there is a 75° angle (See below). Their round outlet orifice and free inside passage minimize the risk of clogging. In addition, compared to standard flat jet nozzles working with a limited operating pressure, the K series models with large spray angles produce an excellent mist effect. These K nozzles are available with threaded connections, for capacities from 0,39 to 350 lpm, and also as tips (KX type) to be assembled onto a nipple by means of a locknut.



SPRAY DISTRIBUTION

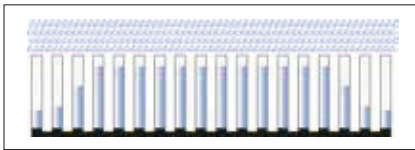

Spiral-shaped distribution

SPRAY ANGLE CODE

W	120°
---	------

SPRAY PATTERN

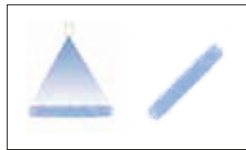

MATERIALS CODE

B1	Stainless Steel AISI 303
B31	Stainless Steel AISI 316L
T1	Brass

HOW TO ORDER PNR PRODUCTS

Model	Connection	Spray Angle	Capacity	Material
K	X	W	0390	XX

Order example: **KGW 0390 B31**

THREAD SIZE

CAPACITY - DIMENSIONS AND WEIGHTS

Here below find thread sizes and nozzles dimensions. Different capacities correspond to different deflection angles. The external dimensions may differ even if the thread size is the same. The table includes the largest nozzles with a given thread size. Please contact our sales for more information.

Model	From size	To size	Thread RG inch	H mm	H1 mm	WS mm	Weight* g			
							Min flow rate		Max flow rate	
							B1/B31	T1	B1/B31	T1
KGW	0390	1120	1/8 BSPT	24	8,5	14	11	12	22	24
KGW	1160	2157	1/8 BSPT	31	10	14	25	27	24	26
KHW	1160	1940	1/4 BSPT	31	12,5	14	25	27	24	26
KHW	2117	2210	1/4 BSPT	34	12,5	14	29	31	28	30
KIW	All range		3/8 BSPT	44	13	17	61	65	58	62
KJW	All range		1/2 BSPT	49	17	22	109	115	101	108
KKW	2700	2940	3/4 BSPT	56	20	36	190	200	180	190
KKW	3110	3164	3/4 BSPT	65	20	36	320	345	310	335
KLW	All range		1 BSPT	92	26	46	800	850	800	850
KXW	All range		Tip type	18	---	---	14	15	10	11

* = Reported weights refer to nozzles with same thread and represent the lowest and the highest flow rate figure of the range.

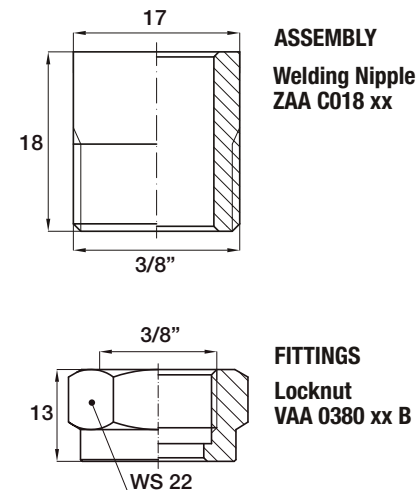
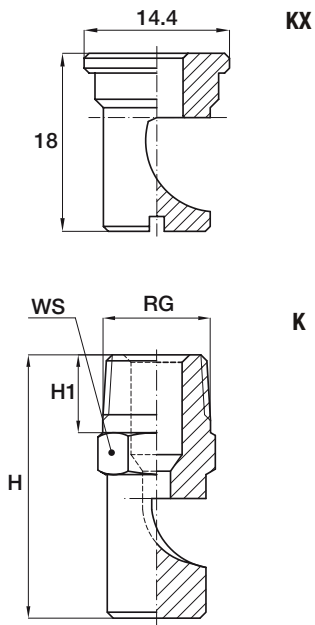

ASSEMBLY
Welding Nipple
ZAA C018 xx

FITTINGS
Locknut
VAA 0380 xx B

The below illustration shows the assembly of a KX nozzle tip (in the middle) with a threaded nipple, a filter and a locknut.

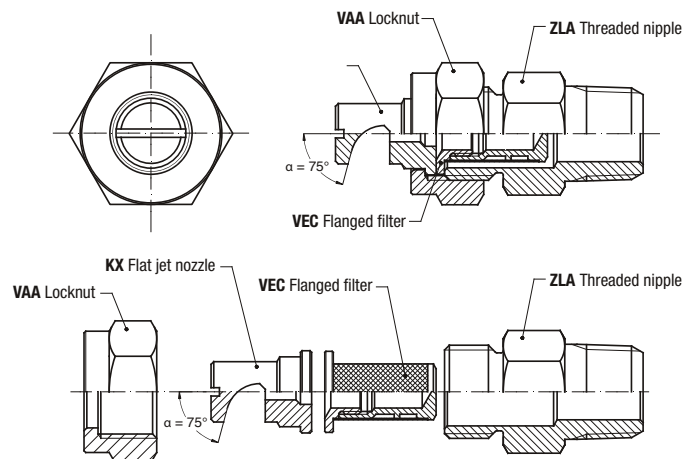

CAPACITY

KGW	KHW	KIW	KJW	KKW	KLW	KXW	Code	D mm	Capacity - lpm							Spray angle	
									Pressure - bar							Pressure - bar	
									0,5	1,0	2,0	3,0	4,0	5,0	7,0	1,5	4,0
•						•	0390	0,6	0,16	0,23	0,32	0,39	0,45	0,50	0,60	90	120
•						•	0590	0,7	0,24	0,34	0,48	0,59	0,68	0,76	0,90	105	120
•						•	0780	0,8	0,32	0,45	0,64	0,78	0,90	1,01	1,19	110	125
•						•	1120	1,0	0,49	0,69	0,98	1,20	1,39	1,55	1,83	105	122
•	•					•	1160	1,1	0,65	0,92	1,31	1,60	1,85	2,07	2,44	110	130
•	•					•	1200	1,3	0,82	1,15	1,63	2,00	2,31	2,58	3,06	120	130
•	•					•	1230	1,4	0,94	1,33	1,88	2,30	2,66	2,97	3,51	110	125
•	•					•	1310	1,6	1,27	1,79	2,53	3,10	3,58	4,00	4,74	120	130
•	•					•	1390	1,8	1,59	2,25	3,18	3,90	4,50	5,03	5,96	130	140
•	•					•	1590	2,3	2,41	3,41	4,82	5,90	6,81	7,62	9,01	120	130
•	•					•	1780	2,6	3,18	4,50	6,37	7,80	9,01	10,1	11,9	130	140
•	•					•	1940	2,9	3,84	5,43	7,68	9,40	10,9	12,1	14,4	140	150
•	•					•	2117	3,3	4,78	6,75	9,55	11,7	13,5	15,1	17,9	110	120
•	•					•	2141	3,6	5,76	8,14	11,5	14,1	16,3	18,2	21,5	120	130
•	•					•	2157	3,8	6,41	9,06	12,8	15,7	18,1	20,3	24,0	120	130
	•					•	2172	4,0	7,02	9,93	14,0	17,2	19,9	22,2	26,3	125	135
	•					•	2188	4,1	7,68	10,9	15,4	18,8	21,7	24,3	28,7	130	140
	•					•	2210	4,4	8,57	12,1	17,1	21,0	24,2	27,1	32,1	135	145
		•				•	2230	4,5	9,39	13,3	18,8	23,0	26,6	29,7	35,1	110	120
		•				•	2270	5,0	11,0	15,6	22,0	27,0	31,2	34,9	41,2	115	125
		•	•			•	2310	5,3	12,7	17,9	25,3	31,0	35,8	40,0	47,4	125	135
		•	•				2350	5,6	14,3	20,2	28,6	35,0	40,4	45,2	53,5	130	140
			•				2390	6,0	15,9	22,5	31,8	39,0	45,0	50,3	59,6	130	140
			•				2470	6,5	19,2	27,1	38,4	47,0	54,3	60,7	71,8	135	140
			•				2550	7,1	22,5	31,8	44,9	55,0	63,5	71,0	84,0	135	145
			•				2630	7,5	25,7	36,4	51,4	63,0	72,7	81,3	96,2	140	150
				•			2700	8,0	28,6	40,4	57,2	70,0	80,8	90,4	107	130	140
				•			2780	8,4	31,8	45,0	63,7	78,0	90,1	101	119	135	145
				•			2860	8,7	35,1	49,7	70,2	86,0	99,3	111	131	135	145
				•			2940	9,3	38,4	54,3	76,8	94,0	109	121	144	140	150
				•			3110	10,3	44,9	63,5	89,8	110	127	142	168	125	135
				•			3125	11,0	51,0	72,2	102	125	144	161	191	130	135
				•			3141	11,4	57,6	81,4	115	141	163	182	215	130	135
				•			3164	12,2	67,0	94,7	134	164	189	212	251	135	145
					•		3235	14,6	95,9	136	192	235	271	303	359	130	135
					•		3350	17,9	143	202	286	350	404	452	535	130	135

TYPICAL APPLICATIONS

- Rolls cooling
- Dust control

OTHERS

- Fire prevention and suppression

CONVERSION TABLE (UE - USA)

PRESSURE: 1 bar = 14,5 psi

CAPACITY: 1 lpm = 0,264 gpm

HOLLOW CONE NOZZLES

PN/PO series moulded plastic nozzles have a high chemical resistance and low prices. They are tangential nozzles and produce an hollow cone spray of atomized droplets. As they have a large free passage and no swirl vane inside their body, they are highly resistant to clogs. PN/PO nozzles are efficient, cost-effective and widely used in many processing.



PN

SPRAY DISTRIBUTION



Hollow distribution

SPRAY ANGLE CODE

S	70°	U	90°
T	80°	Y	130°

MATERIALS CODE

D6	Polypropylene reinforced with fiberglass
-----------	--

SPRAY PATTERN



CONSTRUCTION: Y

- **S** Standard

VERSION: Z

- **G** Parallel thread (BSPP- EN 10226)
- **N** Tapered thread (NPT-ANSI B 1.20)

HOW TO ORDER PNR PRODUCTS

Model	Spray Angle	Capacity	Material	Construction	Version
PN	U	1170	D6	S	Z

Order example: **PNU 1170 D6 SG**

WRENCH SIZE

Code	Inch	WS1	WS2
		mm	mm
PN	3/8"	22	27
	1/2"	30	32
PO	3/8"	-	27
	1/2"	-	32



PO

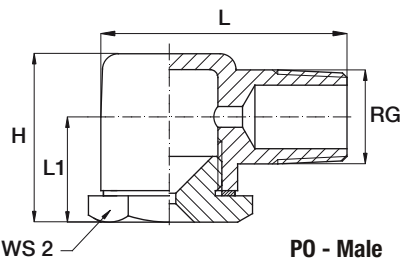
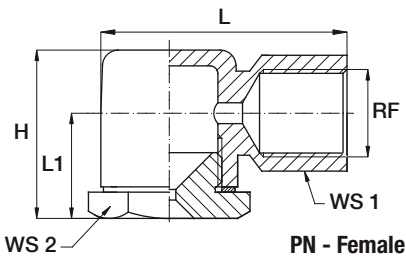

PN FEMALE THREAD NOZZLE

PN female 3/8" thread nozzles are usually connected to piping by ZPN pipe clamps.

For complete view of PNR clamps range consult PNR website.

PN Nozzle with ZPN pipe clamp in Polypropylene



CAPACITY - DIMENSIONS AND WEIGHTS

	PNS	POS	Code	RF RG	DE	DU	Capacity - lpm								Dimensions mm			Weight g	
							Pressure - bar								H	L	L1		D6
							0,5	0,7	1,0	2,0	3,0	5,0	7,0	10					
70°	•	•	1170	3/8	2,0	2,9	0,69	0,82	0,98	1,39	1,70	2,19	2,60	3,10	31	44	20	16	

	PNT	POT	Code	RF RG	DE	DU	Capacity - lpm								Dimensions mm			Weight g	
							Pressure - bar								H	L	L1		D6
							0,5	0,7	1,0	2,0	3,0	5,0	7,0	10					
80°	•	•	1260	3/8	2,7	3,5	1,06	1,26	1,50	2,12	2,60	3,36	3,97	4,75	31	44	20	16	

	PNU	POU	Code	RF RG	DE	DU	Capacity - lpm								Dimensions mm			Weight g	
							Pressure - bar								H	L	L1		D6
							0,5	0,7	1,0	2,0	3,0	5,0	7,0	10					
90°	•		1390	3/8	3,7	3,8	1,59	1,88	2,25	3,18	3,90	5,03	5,96	7,12	31	44	20	17	
	•		1670		4,4	5,2	2,74	3,24	3,87	5,47	6,70	8,65	10,2	12,2					
	•		1850		5,2	5,6	3,47	4,11	4,91	6,94	8,50	11,0	13,0	15,5					
	•		2115		6,1	6,3	4,69	5,56	6,64	9,39	11,5	14,8	17,6	21,0					
	•		2220		7,2	9,2	8,98	10,6	12,7	18,0	22,0	28,4	33,6	40,2					
		•	2320	1/2	9,5	10,5	13,1	15,5	18,5	26,1	32,0	41,3	48,9	58,4	42	55	35	17	
	•	2398	8,5		14,0	16,2	19,2	23,0	32,5	39,8	51,4	60,8	72,7						

	PNY	POY	Code	RF RG	DE	DU	Capacity - lpm								Dimensions mm			Weight Kg	
							Pressure - bar								H	L	L1		D6
							0,5	0,7	1,0	2,0	3,0	5,0	7,0	10					
130°	•	•	1170	3/8	1,7	3,5	0,69	0,82	0,98	1,39	1,70	2,19	2,60	3,10	31	44	20	18	
	•	•	1260		1,9	5,0	1,06	1,26	1,50	2,12	2,60	3,36	3,97	4,75					
	•	•	1390		2,7	5,0	1,59	1,88	2,25	3,18	3,90	5,03	5,96	7,12					
	•	•	1460		3,1	5,0	1,88	2,22	2,66	3,76	4,60	5,94	7,03	8,40					
	•	•	1570		3,0	7,5	2,33	2,75	3,29	4,65	5,70	7,36	8,71	10,4					
	•	•	1670		3,4	7,5	2,74	3,24	3,87	5,47	6,70	8,65	10,2	12,2					
	•	•	1850		4,1	7,5	3,47	4,11	4,91	6,94	8,50	11,0	13,0	15,5					
	•	•	1980		3,6	12,0	4,00	4,73	5,66	8,00	9,80	12,7	15,0	17,9					
	•	•	2128		4,2	12,0	5,23	6,18	7,39	10,5	12,8	16,5	19,6	23,4					
	•	•	2208		6,0	12,0	8,49	10,0	12,0	17,0	20,8	26,9	31,8	38,0					
	•	•	2220	6,4	12,0	8,98	10,6	12,7	18,0	22,0	28,4	33,6	40,2						
	•		2129	1/2	4,3	14,0	5,23	6,18	7,39	10,5	12,8	16,5	19,6	23,4	42	55	35	18	
	•		2209		5,8	14,0	8,49	10,0	12,0	17,0	20,8	26,9	31,8	38,0					
	•		2221		6,3	14,0	8,98	10,6	12,7	18,0	22,0	28,4	33,6	40,2					
	•		2320		7,6	14,0	13,1	15,5	18,5	26,1	32,0	41,3	48,9	58,4					
	•		2420		9,0	14,0	17,1	20,3	24,2	34,3	42,0	54,2	64,2	76,7					

TYPICAL APPLICATIONS

WASHING: exhaust scrubbers, parts cleaning, dust control
COOLING: wire cooling

CONVERSION TABLE (UE - USA)

PRESSURE: 1 bar = 14,5 psi

CAPACITY: 1 lpm = 0,264 gpm



SPRAY DISTRIBUTION

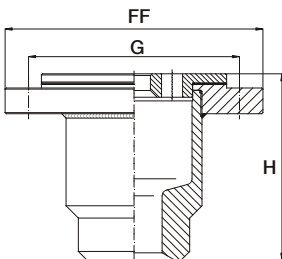
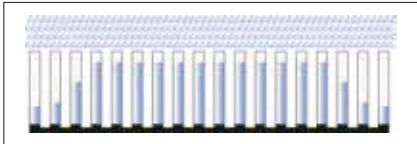

FULL CONE NOZZLES

SLOTTED VANE

AE type nozzles are designed to deliver large and very large capacity values from 384 L/min to 3.842 L/min at 0,5 bar. The carefully designed slotted vane offers uniform spray distribution and perfect performance even with very low inlet pressure values. Compared to other large nozzles, the upper flange reduces the length of nozzles and offers fast and safe ways to install.

SPRAY ANGLE CODE

U	90°	W	120°
----------	-----	----------	------

SPRAY PATTERN

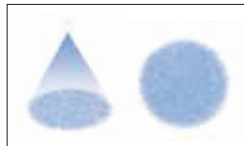

MATERIALS CODE

A1	Carbon steel
B31	Stainless steel AISI 316L
D1	PVC
<i>Other materials available upon request</i>	

CONSTRUCTION: Y

- **S** Standard (cast) PN 10
- **W** Welded type PN 10
- **R** Standard (cast) PN 16
- **V** Welded type PN 16

VERSION: Z

- **E** Flange UNI - EN - DIN
- **G** Flange ANSI B 16.5

HOW TO ORDER PNR PRODUCTS

Model	Spray Angle	Capacity	Material	Construction	Version
AE	U	3940	XX	Y	Z

Order example: AEU 3940 B31 SE

CAPACITY - DIMENSIONS AND WEIGHTS

Code	DN mm	D mm	D1 mm	Capacity - lpm									Dimensions mm			Weight* Kg
				Pressure - bar									FF	G	H	
				0,25	0,35	0,5	0,7	1,0	2,0	3,0	5,0					
90°	80	37,0	12,0	271	321	384	454	543	768	940	1214	200	160	140	8,0	
		39,0	14,0	341	403	482	570	681	963	1180	1523					
	100	43,0	13,0	424	502	600	710	849	1200	1470	1898	220	180	156	10,0	
		125	53,0	16,0	543	642	768	908	1085	1535	1880					2427
	150		56,0	16,0	678	803	959	1135	1357	1919	2350	3034	285	240	188	21,4
		200	59,0	21,0	849	1004	1200	1420	1697	2400	2940	3796				
	250		66,0	24,0	1068	1264	1511	1787	2136	3021	3700	4777	395	350	291	71,0
		250	72,0	28,0	1357	1605	1919	2270	2714	3838	4700	6068				
	250		81,0	32,0	1697	2008	2400	2840	3395	4801	5880	7591	395	350	291	71,0
		250	88,0	39,0	2139	2531	3025	3579	4278	6050	7410	9566				
250	99,0		37,0	2716	3214	3842	4545	5433	7683	9410	12148	395	350	291	71,0	
	120°	80	36,0	15,0	271	321	384	454	543	768	940					1214
40,5			14,5	341	403	482	570	681	963	1180	1523					
100		43,0	18,5	424	502	600	710	849	1200	1470	1898	220	180	156	10,0	
		125	53,0	22,0	543	642	768	908	1085	1535	1880					2427
150			55,0	24,0	678	803	959	1135	1357	1919	2350	3034	285	240	188	21,4
		200	59,0	28,0	849	1004	1200	1420	1697	2400	2940	3796				
200			66,0	32,0	1068	1264	1511	1787	2136	3021	3700	4777	340	295	250	46,0
		250	75,0	35,0	1357	1605	1919	2270	2714	3838	4700	6068				
250			81,0	40,0	1697	2008	2400	2840	3395	4801	5880	7591	395	350	291	71,0
		250	86,0	37,0	2139	2531	3025	3579	4278	6050	7410	9566				
250	96,0		42,0	2716	3214	3842	4545	5433	7683	9410	12148	395	350	291	71,0	

The stated flow rate data are measured at a pressure of 3 bar. For other pressures the Bernoulli formula was applied, with exponent 0,5. Effective flow rate may differ from formula. Please contact PNR if you want to know flow rate data at pressures other than 3 bar.

* = For weight in different materials please contact PNR

TYPICAL APPLICATIONS

Exhaust scrubber
COOLING: Coke quench tower scrubber system
 Exhaust gas cooling

High temperature cooling
CLEANING: Desulfuration



FULL CONE NOZZLES

X-VANE / LARGE CAPACITIES

The BE nozzles produce a full cone spray evenly distributed over a circular area of impact and are used for applications requiring high flow rates up to 11,300 l/min. Whether produced with standard or large spray angles, they provides a high density of spray per square meter. The bodies are obtained by casting and can be supplied both with female thread (BE series) or with ANSI flange (BL series).

SPRAY DISTRIBUTION

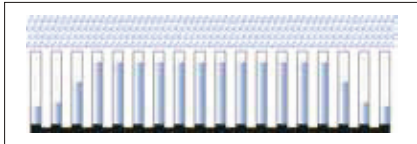

SPRAY ANGLE CODE

U	90°
----------	-----

SPRAY PATTERN

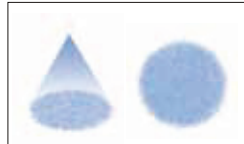

MATERIALS CODE

B31	Stainless steel AISI 316 L
G1	Cast Iron

CONSTRUCTION: Y

- **S** Standard

VERSION: Z

- **G** Parallel thread (BSPP EN 10226)
- **N** Tapered thread (NPT ANSI B 1.20)

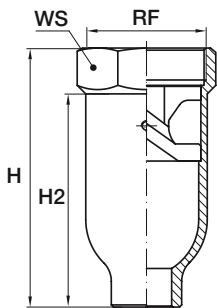

HOW TO ORDER PNR PRODUCTS

Model	Spray Angle	Capacity	Material	Construction	Version
BE	U	4139	XX	Y	Z

Order example: **BEU 4139 B31 SG**

CAPACITY - DIMENSIONS AND WEIGHTS

90°	BEU	Code	RF inch	D mm	D1 mm	Capacity - lpm							Dimensions mm			Weight Kg	
						Pressure- bar							H	H2	WS	B31	G1
						0,7	1,0	2,0	3,0	5,0	7,0	10					
90°	•	4139 xx	4	43	19	671	803	1135	1390	1794	2123	2538	251	207	130	6,0	7,0
		4157 xx		47	22	758	906	1282	1570	2027	2398	2866					
		4174 xx		51	25	840	1005	1421	1740	2246	2658	3177					
		4183 xx		54	25	884	1057	1494	1830	2363	2795	3341					
	•	4218 xx	5	48	29	1053	1259	1780	2180	2814	3330	3980	311	269	170	13,0	14,0
		4244 xx		53	29	1179	1409	1992	2440	3150	3727	4455					
		4279 xx		68	35	1348	1611	2278	2790	3602	4262	5094					
		4287 xx		73	35	1386	1657	2343	2870	3705	4384	5240					
	•	4305 xx	6	61	41	1473	1761	2490	3050	3938	4659	5569	366	321	200	25,0	28,0
		4348 xx		70	41	1681	2009	2841	3480	4493	5316	6354					
		4392 xx		77	44	1894	2263	3201	3920	5061	5988	7157					
		4418 xx		82	44	2019	2413	3413	4180	5396	6385	7632					
	•	4435 xx	8	70	48	2101	2511	3552	4350	5616	6645	7942	470	423	240	36,0	40,0
		4520 xx		80	47	2512	3002	4246	5200	6713	7943	9494					
		4610 xx		91	47	2947	3522	4981	6100	7875	9318	11137					
		4694 xx		102	57	3352	4007	5666	6940	8960	10601	12671					
•	4785 xx		124	57	3792	4532	6409	7850	10134	11991	14332						

TYPICAL APPLICATIONS

Cooling: Metals cooling
Washing: Pre - treatment for coating

CONVERSION TABLE (UE - USA)

PRESSURE: 1 bar = 14,5 psi

CAPACITY: 1 lpm = 0,264 gpm



TANGENTIAL NOZZLES / LARGE FLOW RATES

PR nozzles produce a hollow cone spray based on the tangential jet principle generating atomized flows with large flow rates. They have a large free inside passage and no swirl vane and offer a considerable resistance to clogging and high performances.

SPRAY DISTRIBUTION

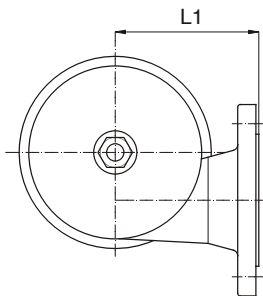
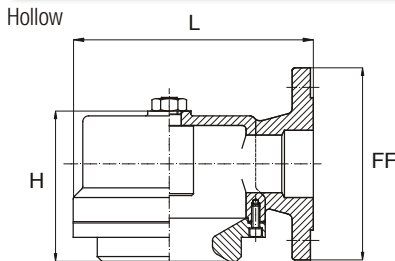
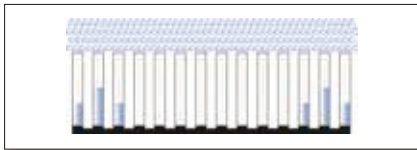

SPRAY ANGLE CODE

Y	130°
----------	------

SPRAY PATTERN



MATERIALS CODE

A1	Carbon steel
B31	Stainless Steel AISI 316L

CONSTRUCTION: Y

- **S** Standard flange assembly (PN 10)
- **X** Special flange assembly (PN 10)
- **R** Standard flange assembly (PN 16)
- **Y** Special flange assembly (PN 16)

VERSION: Z

- **E** EN (UNI) Flange
- **F** ANSI Flange

HOW TO ORDER PNR PRODUCTS

Model	Spray Angle	Capacity	Material	Construction	Version
PR	Y	3612	XX	Y	Z

Order example: **PRY 3612 A1 SE**

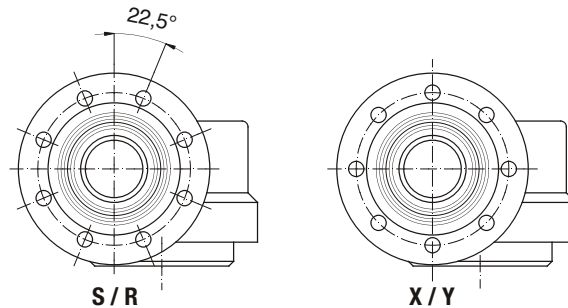

CAPACITY - DIMENSIONS AND WEIGHTS

130°	Code	DN inch	DE mm	DU mm	Capacity - lpm					Dimensions mm				Weight* Kg
					Pressure - bar					FF	H	L	L1	
					0,5	1,0	2,0	3,0	5,0					
130°	PRY 3612 xx	3"	31,0	90	250	353	500	612	790	200	157	250	150	19,5
	PRY 3685 xx		34,0	90	280	395	559	685	884					
	PRY 3771 xx		36,5	90	315	445	630	771	995					
	PRY 3869 xx		39,5	90	355	502	710	869	1122					
	PRY 3979 xx		40,0	90	400	565	799	979	1264					
	PRY 4110 xx		43,0	90	449	635	898	1100	1420					
	PRY 4122 xx		50,0	90	498	704	996	1220	1575					
	PRY 4153 xx		57,0	90	625	883	1249	1530	1975					
	PRY 4195 xx		60,0	145	796	1126	1592	1950	2517					
	PRY 4244 xx		70,0	145	996	1409	1992	2440	3150					
PRY 4306 xx	79,0	145	1249	1767	2498	3060	3950							
PRY 4385 xx	87,0	145	1572	2223	3144	3850	4970							
										220	242	355	200	57,0

* = For weight in different materials please contact PNR







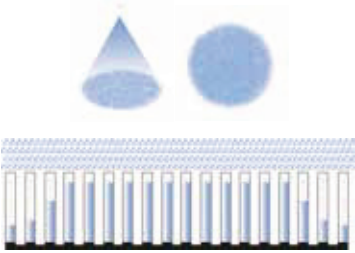

TYPICAL APPLICATIONS

- Desulfurization
- Denitrogening
- Exhaust scrubbers
- Coke quenching towers

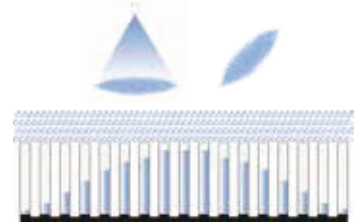
CONVERSION TABLE (UE - USA)

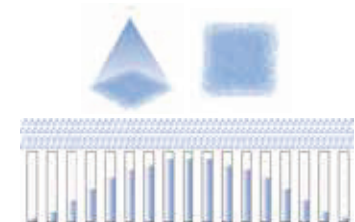
PRESSURE: 1 bar = 14,5 psi

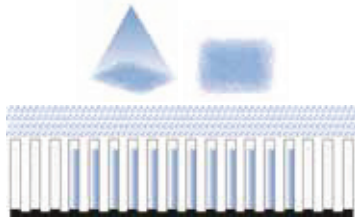
CAPACITY: 1 lpm = 0,264 gpm

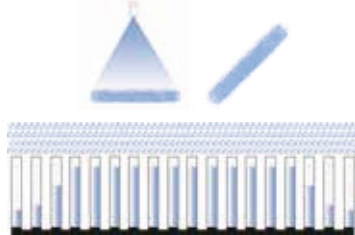
<p>ROUND PATTERN</p>	 <p>AH BA</p>	<p>FEMALE THREAD AH 18 BA 19</p>
	 <p>BC D</p>	<p>MALE THREAD BC 19 D 20</p>
<p>OVAL PATTERN</p>	 <p>BX</p>	<p>ROUND TIP TYPE BX 23</p>
	 <p>D.OB D.PB</p>	<p>MALE THREAD D.OB 24 D.PB 25</p>
<p>SQUARE PATTERN</p>	 <p>BH</p>	<p>MALE THREAD BH 26</p>
	 <p>926</p>	<p>DOUBLE PIN CONNECTION 926 27</p>
<p>RECTANGULAR PATTERN</p>	 <p>GX</p>	<p>ROUND TIP TYPE GX 28</p>
	 <p>GY</p>	<p>DOVETAIL TIP TYPE GY 30</p>
<p>FAN JET PATTERN</p>	 <p>FX FA FB</p>	<p>MALE THREAD HIGH PRESSURE TYPE F 32</p>
		

FULL CONE NOZZLES / DISC VANE (UNIFORM DISTRIBUTION)

The AH type nozzles produce a full cone spray pattern with a very uniform distribution on the entire spray surface. Thanks to the special design of their disc vane they can produce a full cone jet with no central hole, thus offering the nozzle orifice a very high resistance to clogging even in hard operating conditions.



SPRAY DISTRIBUTION

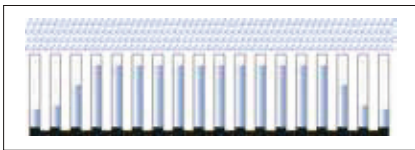

SPRAY ANGLE CODE

R	65°
T	80°

SPRAY PATTERN

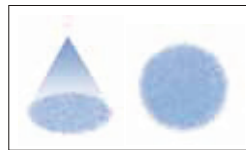

MATERIALS CODE

B1	Stainless steel AISI 303
B31	Stainless steel AISI 316 L
T1	Brass

CONSTRUCTION: Y

- S Standard
- A With safety ring

VERSION: Z

- G Parallel thread (BSPP-EN 10226)
- N Tapered thread (NPT-ANSI B 1.20)

HOW TO ORDER PNR PRODUCTS

Model	Spray Angle	Capacity	Material	Construction	Version
AH	R	1309	XX	Y	Z

Order example: **AHR 1309 T1 SG**

CAPACITY - DIMENSIONS AND WEIGHTS

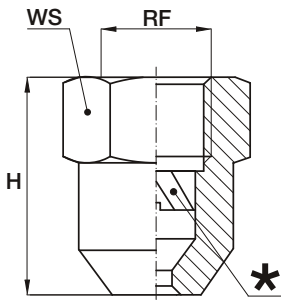

* DISC VANE

This special vane uses a series of peripheral passages to create a swirling motion of the liquid inside the spray chamber. A set of superficial millings on the lower side of the disc act as a brake on the fluid rotation at the center so to obtain a full cone jet with a very even distribution, avoiding to use a small central hole which may get easily clogged.

CONVERSION TABLE (UE - USA)

PRESSURE: 1 bar = 14,5 psi

CAPACITY: 1 lpm = 0,264 gpm

Code	RF inch	D mm	Capacity - lpm					Dimensions mm		Weight g		
			Pressure - bar					H	WS	B31/B1	T1	
			1,0	2,0	3,0	4,0	5,0					
65°	1/4	1,9	1,79	2,53	3,10	3,58	4,00	27,5	19	45	50	
		2,0	2,08	2,94	3,60	4,16	4,65					
		2,2	2,37	3,35	4,10	4,73	5,29					
	3/8	3/8	1,0	1,21	1,71	2,10	2,42	2,71	25,0	22	45	50
			1,9	1,79	2,53	3,10	3,58	4,00				
			2,0	1,96	2,78	3,40	3,93	4,39				
			2,1	2,08	2,94	3,60	4,16	4,65				
			2,2	2,35	3,39	4,15	4,79	5,31				
			2,4	2,71	3,84	4,70	5,43	6,07				
			2,6	3,00	4,25	5,18	5,98	6,68				
			2,7	3,58	5,06	6,20	7,16	8,00				
			2,9	4,50	6,37	7,80	9,01	10,12				
			3,1	4,79	6,76	8,28	9,56	10,68				
			4,2	6,35	8,98	11,00	12,70	14,24				
4,2	8,31	11,76	14,40	16,63	18,62							
80°	1/4	2,2	1,79	2,53	3,10	3,58	4,00	27,5	19	45	50	
		2,2	2,08	2,94	3,60	4,16	4,65					
		2,2	2,37	3,35	4,10	4,73	5,29					
	3/8	3/8	2,0	1,79	2,53	3,10	3,58	4,00	25,0	22	45	50
			2,1	2,08	2,94	3,60	4,16	4,65				
			2,2	2,37	3,35	4,10	4,73	5,29				
			2,6	3,00	4,23	5,18	5,98	6,68				
			2,7	3,58	5,06	6,20	7,16	8,00				
			2,9	4,50	6,37	7,80	9,01	10,07				
			3,1	4,78	6,76	8,28	9,56	10,68				
			4,2	6,35	8,98	11,00	12,70	14,20				
			4,2	8,31	11,76	14,40	16,63	18,62				

X - VANE / ROUND SPRAY / THREE PIECES DESIGN / EASY CLEAN

BA/BC Series full cone nozzles have a three-pieces design made of body, X-vane and nipple. Their X-vane design combines resistance in clogging with the convenience of an easy and fast inside cleaning as they can be easily disassembled for maintenance. When these nozzles are mounted to spray upwards, the design of the nipple avoids losing the vane. BA/BC nozzles are available with a female (BA) or male (BC) inlet thread nipple. See dimensions and weight at the bottom of the page.



SPRAY ANGLE CODE

Q	60°
W	120°

MATERIALS CODE

B1	Stainless steel AISI 303
B31	Stainless steel AISI 316 L
T1	Brass

VERSION: Z

- **S** Standard

THREAD CODE

- **G** Parallel thread (BSPP-EN 10226)
- **B** Tapered thread (BSPT EN -10226)
- **N** Conical thread (NPT ANSI B 1.20)

SPRAY DISTRIBUTION

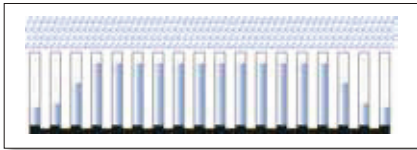

SPRAY PATTERN

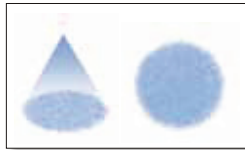

HOW TO ORDER PNR PRODUCTS

Model	Spray Angle	Capacity	Material	Version	Thread
BA	Q	0740	B31	S	N

Order example: **BAQ 0740 B31 SN**

Standard Spray

CAPACITY - DIMENSIONS AND WEIGHTS

Model	Code	RF RG	D mm	D1 mm	Capacity - lpm						Spray angle			Dimensions mm		Weight g	
					Pressure - bar						Pressure - bar			H	WS	B31/B1	T1
					0,7	1,0	3,0	6,0	7,0	10	0,5	1,5	6,0				
BA	0740	1/8	1,0	0,5	0,36	0,43	0,74	1,05	1,13	1,35	-	58°	53°	30	14	25,0	30,0
	1110		1,2	0,5	0,53	0,64	1,10	1,56	1,68	2,01	52°	65°	59°				
	1150		1,4	1,0	0,72	0,87	1,50	2,12	2,29	2,74	43°	50°	46°				
	1220		1,6	1,0	1,06	1,27	2,20	3,11	3,36	4,02	52°	65°	59°				
	1260		1,6	1,3	1,26	1,50	2,60	3,68	3,97	4,75	43°	50°	46°				
	1370	2,0	1,3	1,79	2,14	3,70	5,23	5,65	6,76	52°	65°	59°					
	1480	2,4	1,7	2,32	2,77	4,80	6,79	7,33	8,76	45°	50°	46°					
	1740	2,9	1,7	3,57	4,27	7,40	10,5	11,3	13,5	58°	67°	61°					
	1930	3,2	1,7	4,49	5,37	9,30	13,2	14,2	17,0	69°	74°	68°					
	1700	3,0	2,0	3,38	4,04	7,00	9,90	10,69	12,78	45°	50°	46°					
2111	3,4	2,4	5,36	6,41	11,1	15,7	17,0	20,3	64°	67°	61°						
2163	4,5	2,4	7,87	9,41	16,3	23,1	24,9	29,8	87°	90°	82°						
2118	3,4	3,0	5,70	6,81	11,8	16,7	18,0	21,5	48°	50°	46°						
2185	4,4	3,0	8,94	10,7	18,5	26,2	28,3	33,8	64°	67°	61°						
2240	5,0	3,0	11,6	13,9	24,0	33,9	36,7	43,8	72°	75°	68°						
2300	5,6	3,0	14,5	17,3	30,0	42,4	45,8	54,8	88°	91°	83°						

**Standard Spray
BAQ (Female)
BCQ (Male)**

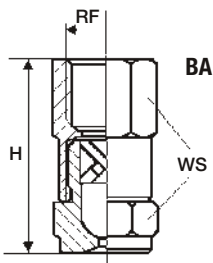

**Wide spray
BAW - BCW**

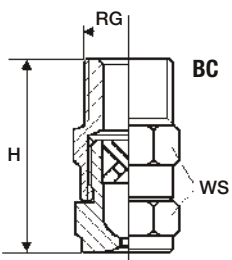

D

CONTINUOUS CASTING COOLING (WATER)

FULL CONE NOZZLES

The D series full cone nozzles offer a simple yet efficient design which consists of a body with male thread and an X-vane with large passage. The insert is locked into place for all sizes up to 3/8" included which allows the nozzle assembly in any desired orientation without danger. Normally available from stock in the below listed materials



SPRAY DISTRIBUTION

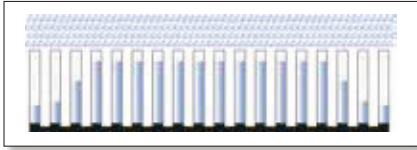

SPRAY ANGLE CODE

M	45°	U	90°
Q	60°	W	120°

SPRAY PATTERN

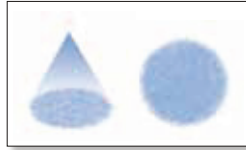

THREADED CONNECTION CODES

Code	RG inch	H mm	WS mm
DA	1/8	19.5	12.0
DB	1/4	22.0	14.0
DC	3/8	25.0	17.0
DD	1/2	33.0	22.0

MATERIALS CODE

B1	Stainless Steel AISI 303
B31	Stainless Steel AISI 316L
T1	Brass

CONSTRUCTION: Y

- S Standard
- A With safety ring

VERSION: Z

- B Tapered thread (BSPT-EN 10226)
- N Tapered thread (NPT- ANSI B 1.20)
- G Parallel thread (BSPP-EN 10226)

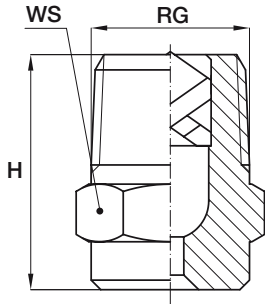

HOW TO ORDER PNR PRODUCTS

Model	Thread	Spray Angle	Capacity	Material	Construction	Version
D	A	U	1118	XX	Y	Z

Order example: **DAU 1118 T1 SB**

CAPACITY (WEIGHTS at page 22)

45°	DAM	DBM	DCM	DDM	Code	D mm	D1 mm	Capacity - lpm						
								Pressure - bar						
								0,7	1,0	2,0	3,0	5,0	7,0	10
•	•				1118 xx	1,1	1,0	0,57	0,68	0,96	1,18	1,52	1,80	2,15
•	•				1147 xx	1,2	1,1	0,71	0,85	1,20	1,47	1,90	2,25	2,68
•	•				1188 xx	1,3	1,0	0,91	1,09	1,54	1,88	2,43	2,87	3,43
•	•				1212 xx	1,4	1,2	1,02	1,22	1,73	2,12	2,74	3,24	3,87
•	•				1235 xx	1,5	1,3	1,14	1,36	1,92	2,35	3,03	3,59	4,29
•	•	•			1294 xx	1,7	1,5	1,42	1,70	2,40	2,94	3,80	4,49	5,37
•	•	•			1370 xx	2,0	1,8	1,79	2,14	3,02	3,70	4,78	5,65	6,76
	•	•	•		1470 xx	2,1	2,0	2,27	2,71	3,84	4,70	6,07	7,18	8,58
	•	•	•		1588 xx	2,3	2,0	2,84	3,39	4,80	5,88	7,59	8,98	10,7
	•	•	•		1659 xx	2,5	2,2	3,18	3,80	5,38	6,59	8,51	10,1	12,0
	•	•	•		1740 xx	2,7	2,3	3,57	4,27	6,04	7,40	9,55	11,3	13,5
		•	•		1835 xx	2,8	2,6	4,03	4,82	6,82	8,35	10,8	12,8	15,2
		•	•		1940 xx	3,0	3,0	4,54	5,43	7,68	9,40	12,1	14,4	17,2
		•	•		2105 xx	3,2	3,2	5,07	6,06	8,57	10,5	13,6	16,0	19,2
		•	•		2117 xx	3,3	3,3	5,65	6,75	9,55	11,7	15,1	17,9	21,4
		•	•		2147 xx	3,8	3,7	7,10	8,49	12,0	14,7	19,0	22,5	26,8
			•		2188 xx	4,3	4,3	9,08	10,9	15,4	18,8	24,3	28,7	34,3
			•		2235 xx	5,0	4,5	11,4	13,6	19,2	23,5	30,3	35,9	42,9

CONVERSION TABLE (UE - USA)

PRESSURE: 1 bar = 14,5 psi

CAPACITY: 1 lpm = 0,264 gpm

CAPACITY (WEIGHTS at page 22)

	DAQ	DBQ	DCQ	DDQ	Code	D mm	D1 mm	Capacity - lpm								
								Pressure - bar								
								0,7	1,0	2,0	3,0	5,0	7,0	10		
60°	•				1118 xx	1,2	0,8	0,57	0,68	0,96	1,18	1,52	1,80	2,15		
	•				1147 xx	1,3	1,0	0,71	0,85	1,20	1,47	1,90	2,25	2,68		
	•				1188 xx	1,4	1,1	0,91	1,09	1,54	1,88	2,43	2,87	3,43		
	•	•			1212 xx	1,5	1,2	1,02	1,22	1,73	2,12	2,74	3,24	3,87		
	•	•			1235 xx	1,6	1,2	1,14	1,36	1,92	2,35	3,03	3,59	4,29		
	•	•	•		1294 xx	1,8	1,3	1,42	1,70	2,40	2,94	3,80	4,49	5,37		
	•	•	•		1370 xx	2,0	1,4	1,79	2,14	3,02	3,70	4,78	5,65	6,76		
	•	•	•		1470 xx	2,4	1,9	2,27	2,71	3,84	4,70	6,07	7,18	8,58		
		•	•		1588 xx	2,6	2,0	2,84	3,39	4,80	5,88	7,59	8,98	10,7		
		•	•		1659 xx	2,7	2,0	3,18	3,80	5,38	6,59	8,51	10,1	12,0		
		•	•		1740 xx	2,9	2,0	3,57	4,27	6,04	7,40	9,55	11,3	13,5		
		•	•		1835 xx	3,2	2,8	4,03	4,82	6,82	8,35	10,8	12,8	15,2		
		•	•		1940 xx	3,2	2,8	4,54	5,43	7,68	9,40	12,1	14,4	17,2		
		•	•	•	2105 xx	3,4	3,0	5,07	6,06	8,57	10,5	13,6	16,0	19,2		
			•	•	2117 xx	3,6	3,0	5,65	6,75	9,55	11,7	15,1	17,9	21,4		
				•	2147 xx	4,0	3,3	7,10	8,49	12,0	14,7	19,0	22,5	26,8		
			•	2188 xx	4,5	3,7	9,08	10,9	15,4	18,8	24,3	28,7	34,3			
			•	2235 xx	5,2	4,5	11,4	13,6	19,2	23,5	30,3	35,9	42,9			
			•	2294 xx	5,8	4,7	14,2	17,0	24,0	29,4	38,0	44,9	53,7			

	DAU	DBU	DCU	DDU	Code	D mm	D1 mm	Capacity - lpm								
								Pressure - bar								
								0,7	1,0	2,0	3,0	5,0	7,0	10		
90°	•				1118 xx	1,2	0,8	0,57	0,68	0,96	1,18	1,52	1,80	2,15		
	•				1147 xx	1,3	1,0	0,71	0,85	1,20	1,47	1,90	2,25	2,68		
	•	•			1188 xx	1,4	1,2	0,91	1,09	1,54	1,88	2,43	2,87	3,43		
	•	•			1212 xx	1,5	1,2	1,02	1,22	1,73	2,12	2,74	3,24	3,87		
	•	•	•		1235 xx	1,6	1,3	1,14	1,36	1,92	2,35	3,03	3,59	4,29		
	•	•	•		1294 xx	1,8	1,3	1,42	1,70	2,40	2,94	3,80	4,49	5,37		
	•	•	•		1370 xx	2,0	1,4	1,79	2,14	3,02	3,70	4,78	5,65	6,76		
		•	•		1470 xx	2,3	1,8	2,27	2,71	3,84	4,70	6,07	7,18	8,58		
		•	•		1588 xx	2,6	1,8	2,84	3,39	4,80	5,88	7,59	8,98	10,7		
		•	•		1659 xx	2,7	2,0	3,18	3,80	5,38	6,59	8,51	10,1	12,0		
		•	•		1740 xx	2,9	2,0	3,57	4,27	6,04	7,40	9,55	11,3	13,5		
		•	•		1835 xx	3,3	2,0	4,03	4,82	6,82	8,35	10,8	12,8	15,2		
		•	•		1940 xx	3,3	2,4	4,54	5,43	7,68	9,40	12,1	14,4	17,2		
		•	•		2105 xx	3,5	2,6	5,07	6,06	8,57	10,5	13,6	16,0	19,2		
			•		2117 xx	3,7	2,7	5,65	6,75	9,55	11,7	15,1	17,9	21,4		
			•	•	2147 xx	4,0	3,2	7,10	8,49	12,0	14,7	19,0	22,5	26,8		
			•	•	2164 xx	4,1	3,2	7,92	9,5	13,4	16,4	21,2	25,1	29,9		
			•	•	2188 xx	4,7	3,2	9,08	10,9	15,4	18,8	24,3	28,7	34,3		
			•	•	2235 xx	5,2	3,8	11,4	13,6	19,2	23,5	30,3	35,9	42,9		
			•	2294 xx	5,8	3,8	14,2	17,0	24,0	29,4	38,0	44,9	53,7			
			•	2370 xx	6,4	3,8	17,9	21,4	30,2	37,0	47,8	56,5	67,6			

▷ continued on page 22

CAPACITY

	DAW	DBW	DCW	DDW	Code	D mm	D1 mm	Capacity - lpm						
								Pressure - bar						
								0,7	1,0	2,0	3,0	5,0	7,0	10
120°	•				1118 xx	1,2	0,8	0,57	0,68	0,96	1,18	1,52	1,80	2,15
	•				1147 xx	1,3	0,9	0,71	0,85	1,20	1,47	1,90	2,25	2,68
	•				1188 xx	1,5	1,0	0,91	1,09	1,54	1,88	2,43	2,87	3,43
	•				1212 xx	1,6	1,1	1,02	1,22	1,73	2,12	2,74	3,24	3,87
	•				1235 xx	1,6	1,2	1,14	1,36	1,92	2,35	3,03	3,59	4,29
	•				1294 xx	1,9	1,3	1,42	1,70	2,40	2,94	3,80	4,49	5,37
	•				1370 xx	2,1	1,4	1,79	2,14	3,02	3,70	4,78	5,65	6,76
		•	•		1470 xx	2,4	1,6	2,27	2,71	3,84	4,70	6,07	7,18	8,58
		•	•		1588 xx	2,7	1,8	2,84	3,39	4,80	5,88	7,59	8,98	10,7
		•	•		1659 xx	3,0	1,8	3,18	3,80	5,38	6,59	8,51	10,1	12,0
		•	•		1740 xx	3,1	1,9	3,57	4,27	6,04	7,40	9,55	11,3	13,5
		•	•		1835 xx	3,3	1,9	4,03	4,82	6,82	8,35	10,8	12,8	15,2
		•	•		1940 xx	3,5	1,9	4,54	5,43	7,68	9,40	12,1	14,4	17,2
		•	•		2105 xx	3,7	2,3	5,07	6,06	8,57	10,5	13,5	16,0	19,2
			•		2117 xx	3,8	2,4	5,65	6,75	9,55	11,7	15,1	17,9	21,4
			•		2147 xx	4,2	2,7	7,10	8,49	12,0	14,7	19,0	22,5	26,8
			•		2164 xx	4,4	2,7	7,92	9,47	13,4	16,4	21,2	25,1	29,9
			•	•	2188 xx	4,6	3,1	9,08	10,9	15,4	18,8	24,3	28,7	34,3
				•	2235 xx	5,3	3,3	11,4	13,6	19,2	23,5	30,3	35,9	42,9
				•	2294 xx	5,9	4,1	14,2	17,0	24,0	29,4	38,0	44,9	53,7
			•	2370 xx	6,6	4,7	17,9	21,4	30,2	37,0	47,8	56,5	67,6	

WEIGHTS

Model	From Size	To Size	Weight g	
			B1/B31	T1
DA - 1/8"	1118	1235	11	12
	1294	1470	10	11
DB - 1/4"	1118	1588	20	21
	1659	1835	18	19
DC - 3/8"	1235	1740	35	36
	1835	2235	30	31
DD - 1/2"	1470	2105	67	71
	2117	2370	61	66

CONVERSION TABLE (UE - USA)

PRESSURE: 1 bar = 14,5 psi

CAPACITY: 1 lpm = 0,264 gpm



FULL CONE NOZZLE TIPS

These nozzles produce a full cone spray pattern with a circular impact area. The complete nozzle is made of tip, nipple and ring and this type of construction allows to disassemble the tip quickly and easily for maintenance in case of clogging.

SPRAY DISTRIBUTION

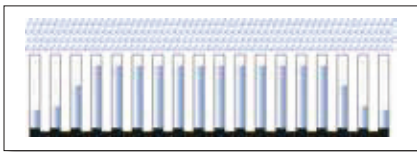

SPRAY ANGLE CODE

Q	60°
---	-----

SPRAY PATTERN

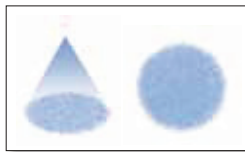

MATERIALS CODE

B1	Stainless steel AISI 303
B31	Stainless steel AISI 316 L
T1	Brass

CONSTRUCTION: Y

- S Standard

VERSION: Z

- B Tip type

HOW TO ORDER PNR PRODUCTS

Model	Spray Angle	Capacity	Material	Construction	Version
BX	Q	1149	XX	Y	Z

Order example: **BXQ 1149 B31 SB**

Under Certain conditions, for example nozzles that spray upward at high temperatures, or in case of sudden vacuum conditions in the pipes, the nozzle vane may exit from its housing and impair the functionality of the nozzle itself. Our nozzles with X-vanes, wire size and thread dimension of 3/8" have the vane safely secured in place.

MOUNTING ACCESSORIES:

BX nozzles are secured by using a weld nipple (ZAA) and a Lock Nut (VAA).

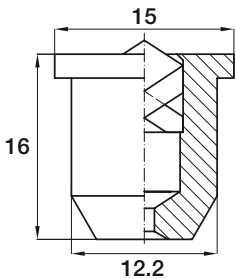

BX 1149 1372

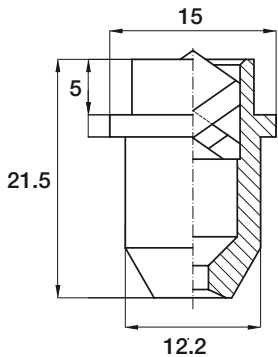

BX 1508 1743



ZAA C018 xx

VAA 0380 xxB

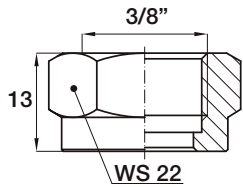

VAA 0380 xxB

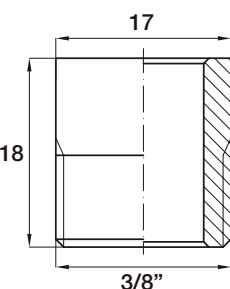

ZAA C018 xx

CAPACITY - DIMENSIONS AND WEIGHTS

Code	D mm	Capacity - lpm						Spray angle			Weight g	
		Pressure - bar						Pressure - bar			B1/B31	T1
		1,0	2,0	3,0	5,0	10	1,5	3,0	5,0			
60°	BXQ 1149 xx	1,3	0,86	1,22	1,49	1,92	2,72	50°	50°	45°	12	14
	BXQ 1223 xx	1,7	1,35	1,90	2,33	3,01	4,25	65°	65°	49°	12	14
	BXQ 1262 xx	1,7	1,51	2,14	2,62	3,38	4,78	50°	50°	46°	12	13
	BXQ 1372 xx	2,1	2,15	3,04	3,72	4,80	6,79	65°	65°	59°	12	13
	BXQ 1508 xx	2,4	2,93	4,15	5,08	6,56	9,27	50°	50°	46°	12	13
	BXQ 1570 xx	2,8	3,29	4,65	5,70	7,36	10,4	62°	65°	65°	12	13
	BXQ 1626 xx	2,9	3,61	5,11	6,26	8,08	11,4	60°	60°	55°	12	13
	BXQ 1743 xx	2,9	4,29	6,1	7,43	9,59	13,6	67°	67°	61°	12	13

CONVERSION TABLE (UE - USA)

PRESSURE: 1 bar = 14,5 psi

CAPACITY: 1 lpm = 0,264 gpm



OVAL JET NOZZLES

These D..OB full cone nozzles with oval spray pattern are used for continuous casting cooling. Their jets, covering an oblong surface, can be easily positioned to ensure a very uniform cooling action. Their construction in two pieces, body and X-vane, offers the same benefits of the normal full cone nozzle in terms of resistance to clogging and a secure vane.

SPRAY ANGLE CODE

U..0	$\alpha = 90^\circ$
	$\beta = 60^\circ$

THREAD CODE

B	1/4"
C	3/8"

MATERIALS CODE

B1	Stainless steel AISI 303
T1	Brass

SPRAY DISTRIBUTION

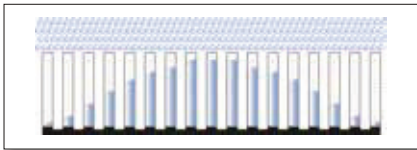

SPRAY PATTERN

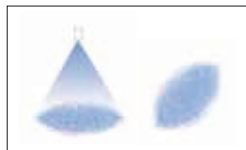

CONSTRUCTION: Y

- O Oval
- $\alpha = 90^\circ$
- $\beta = 60^\circ$

VERSION: Z

- B Tapered thread (BSPT-EN 10226)

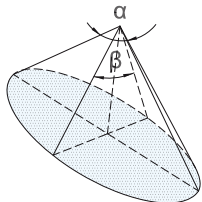
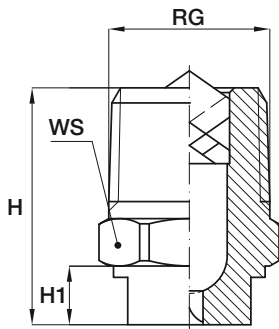

HOW TO ORDER PNR PRODUCTS

Model	Thread	Spray Angle	Capacity	Material	Construction	Version
D	B	U..0	1330	XX	Y	Z

Order example: **DBU 1330 T1 OB**

CAPACITY - DIMENSIONS AND WEIGHTS

α	β	Code	RG inch	D1 mm	Capacity - lpm							Dimensions mm			Weight g		
					Pressure - bar							H	H1	WS	B1	T1	
							0,7	1,5	2,0	3,0	4,0						6,0
90°	60°	DBU 1330xx OB	1/4	1,2	1,60	2,34	2,69	3,32	3,81	4,65	5,07	6,06	22	5	14	19	18
		DBU 1420xx OB		1,4	2,03	2,97	3,42	4,21	4,85	5,92	6,43	7,68					
		DBU 1540xx OB		1,7	2,62	3,83	4,41	5,44	6,23	7,65	8,31	9,93					
		DBU 1720xx OB		1,9	3,48	5,09	5,87	7,22	8,31	10,2	11,0	13,2					
		DBU 1780xx OB		2,1	3,67	5,37	6,22	7,61	8,78	10,8	11,6	13,9					
		DBU 1840xx OB		2,2	4,05	5,92	6,85	8,39	9,69	11,9	12,8	15,3					
90°	60°	DCU 1320xx OB	3/8	1,1	1,55	2,26	2,61	3,20	3,70	4,53	4,89	5,84	25	5	17	36	35
		DCU 1400xx OB		1,3	1,93	2,83	3,27	4,00	4,62	5,66	6,11	7,30					
		DCU 1520xx OB		1,6	2,52	3,68	4,25	5,20	6,00	7,35	7,94	9,49					
		DCU 1680xx OB		1,6	3,28	4,81	5,55	6,80	7,85	9,62	10,4	12,4					
		DCU 1800xx OB		2	3,86	5,66	6,53	8,00	9,24	11,3	12,2	14,6					

TYPICAL APPLICATIONS

Continuous casting

CONVERSION TABLE (UE - USA)

PRESSURE: 1 bar = 14,5 psi
CAPACITY: 1 lpm = 0,264 gpm



OVAL JET NOZZLES

The full cone nozzles with oval spray pattern D..PB series have the same characteristics and features of the D..OB series nozzles, but with operating angles at 90° and 30°.

SPRAY ANGLE CODE

U..P	$\alpha = 90^\circ$
	$\beta = 30^\circ$

THREAD CODE

B	1/4"
C	3/8"

MATERIALS CODE

B1	Stainless steel AISI 303
T1	Brass

SPRAY DISTRIBUTION

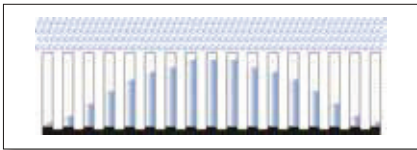

SPRAY PATTERN



CONSTRUCTION: Y

- O Oval
- $\alpha = 90^\circ$
- $\beta = 30^\circ$

VERSION: Z

- B Tapered thread (BSPT-EN 10226)

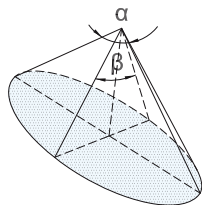
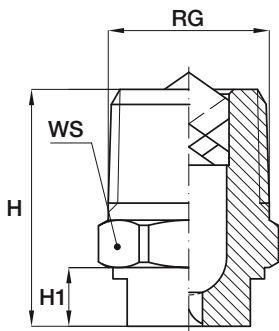

HOW TO ORDER PNR PRODUCTS

Model	Thread	Spray Angle	Capacity	Material	Construction	Version
D	B	U..P	1330	XX	Y	Z

Order example: DBU 1330 T1 PB

CAPACITY - DIMENSIONS AND WEIGHTS

α	β	Code	RG inch	D1 mm	Capacity - lpm							Dimensions mm			Weight g		
					Pressure - bar							H	H1	WS	B1	T1	
							0,7	1,5	2,0	3,0	4,0						6,0
90°	30°	DBU 1330xx PB	1/4	1,2	1,60	2,34	2,69	3,32	3,81	4,65	5,07	6,06	22	5	14	19	18
		DBU 1420xx PB		1,4	2,03	2,97	3,42	4,21	4,85	5,92	6,43	7,68					
		DBU 1540xx PB		1,7	2,62	3,83	4,41	5,44	6,23	7,65	8,31	9,93					
		DBU 1720xx PB		1,9	3,48	5,09	5,87	7,22	8,31	10,2	11,0	13,2					
		DBU 1780xx PB		2,1	3,67	5,37	6,22	7,61	8,78	10,8	11,6	13,9					
		DBU 1840xx PB		2,2	4,05	5,92	6,85	8,39	9,69	11,9	12,8	15,3					
90°	30°	DCU 1240xx PB	3/8	0,90	1,16	1,70	1,96	2,40	2,77	3,40	3,67	4,38	25	5	17	36	35
		DCU 1320xx PB		1,1	1,55	2,26	2,61	3,20	3,70	4,53	4,89	5,84					
		DCU 1410xx PB		1,3	1,93	2,83	3,27	4,00	4,62	5,66	6,11	7,30					
		DCU 1540xx PB		1,6	2,52	3,68	4,25	5,20	6,00	7,35	7,94	9,49					
		DCU 1680xx PB		1,6	3,28	4,81	5,55	6,80	7,85	9,62	10,4	12,4					
		DCU 1840xx PB		2	3,86	5,66	6,53	8,00	9,24	11,3	12,2	14,6					

TYPICAL APPLICATIONS

Continuous casting
Cooling

CONVERSION TABLE (UE - USA)

PRESSURE: 1 bar = 14,5 psi

CAPACITY: 1 lpm = 0,264 gpm

FULL CONE NOZZLES

X-VANE / SQUARE SPRAY PATTERN / 2 PIECES

Depending on their size, these nozzles are produced from bars or castings (see drawings on the page), size and weight as per below table. They are the convenient choice when the coverage of an area should be as uniform as possible. It's worth noting that the sides of the square section of the jet are not in line with the grooves of the nozzle orifice, the deviation angle is between 10° and 15° depending on the working pressure and distance. The proper alignment should be obtained at the time of installation or maintenance.



SPRAY ANGLE CODE

Q	60°
W	120°

MATERIALS CODE

B1	Stainless steel AISI 303
B31	Stainless steel AISI 316 L
T1	Brass

CONSTRUCTION: Y

- **S** Standard

VERSION: Z

- **B** Tapered thread (BSPT-EN 10226-2)
- **N** Tapered thread (NPT-ANSI B 1.20.1)

SPRAY DISTRIBUTION

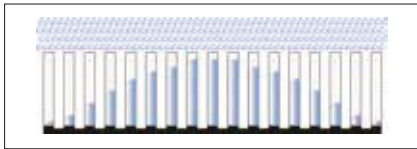

SPRAY PATTERN

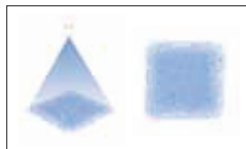

HOW TO ORDER PNR PRODUCTS

Model	Spray Angle	Capacity	Material	Construction	Version
BH	Q	1270	XX	Y	Z

Order example: **BHW 1270 B31 SB**

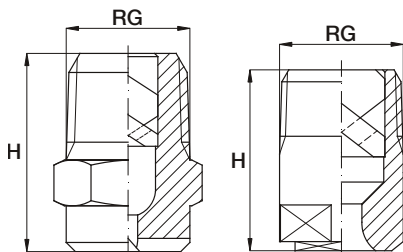

1/8" to 1/2" Size

3/4" Size

CAPACITY - DIMENSIONS AND WEIGHTS

60°	Code	RG inch	D mm	D1 mm	Capacity - lpm								Spray angle			Dimensions mm		Weight g				
					Pressure - bar								Pressure - bar			H	WS	B31/B1	T1			
					0,7	1,0	2,0	3,0	5,0	7,0	10	0,7	3,0	5,0								
60°	BHQ 1270xx	1/8	1,7	1,3	1,30	1,56	2,20	2,70	3,49	4,12	4,93	52	60	58	22	12	10	11				
	BHQ 1350xx		1,9	1,3	1,74	2,08	2,94	3,60	4,65	5,50	6,57	58	60	60								
	BHQ 1440xx		2,2	1,3	2,13	2,54	3,59	4,40	5,68	6,72	8,03	60	65	60								
	60°	BHQ 1740xx	1/4	2,8	1,6	3,57	4,27	6,04	7,40	9,55	11,3	13,5	62	65	60	23	14	18	20			
		BHQ 1890xx		3,2	1,6	4,30	5,14	7,27	8,90	11,5	13,6	16,2	62	65	60							
		BHQ 2107xx		3,8	1,6	5,17	6,18	8,74	10,7	13,8	16,3	19,5	65	65	60							
	60°	BHQ 2133xx	3/8	4,0	2,4	6,42	7,68	10,9	13,3	17,2	20,3	24,3	60	62	60	30	17	32	35			
		BHQ 2210xx	1/2	5,5	3,2	10,1	12,1	17,2	21,0	27,1	32,1	38,3	62	64	60							
		BHQ 2270xx		6,4	3,2	13,0	15,6	22,0	27,0	34,8	41,2	49,2	62	65	60							
120°	BHQ 2370xx	3/4	6,7	4,4	17,8	22,0	31,0	37,0	47,8	56,5	67,5	60	64	62	39	21	63	68				
	BHW 2100xx	1/4	3,2	1,6	4,83	5,77	8,16	10,0	12,9	15,3	18,3	106	115	100					23	14	16	17
	BHW 2122xx	3/8	3,9	1,6	5,89	7,04	9,96	12,2	15,8	18,6	22,3	105	120	110								
	BHW 2144xx		4,0	2,4	6,96	8,31	11,8	14,4	18,6	22,0	26,3	105	120	110								
	BHW 2172xx		4,6	2,4	8,31	9,93	14,0	17,2	22,2	26,3	31,4	105	120	105								
	BHW 2194xx		5,4	2,4	9,37	11,2	15,8	19,4	25,0	29,6	35,4	105	120	106								
	BHW 2220xx	1/2	4,8	3,0	10,6	12,7	18,0	22,0	28,4	33,6	40,2	105	110	105								
	BHW 2250xx		5,1	3,0	12,1	14,4	20,4	25,0	32,3	38,2	45,6	105	110	105								
	BHW 2290xx	1/2	5,7	3,0	14,0	16,7	23,7	29,0	37,4	44,3	53,0	105	110	105								
	BHW 2320xx		7,0	3,0	15,4	18,5	26,1	32,0	41,3	48,9	58,4	105	110	105								
BHW 2360xx	8,0		3,0	17,4	20,8	29,4	36,0	46,5	55,0	65,7	105	110	105									
BHW 2500xx	3/4	8,5	4,5	24,2	28,9	40,8	50,0	64,5	76,4	91,3	105	115	103	55	27	95	105					



RECTANGULAR JET NOZZLE TIPS

The 926 series nozzles produce a rectangular spray pattern, ideal for continuous castings coverage. They can be supplied as tips with welding nipple and locknut or, on request, with female or male thread.

For any requirements about 926 series please contact our offices.

SPRAY DISTRIBUTION

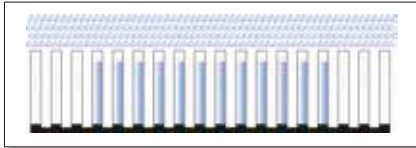

SPRAY PATTERN

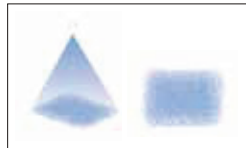

MATERIALS CODE

T1 Brass

CONSTRUCTION: Y

- S Standard

VERSION: Z

- T Tip connection

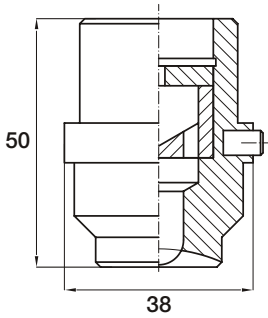

HOW TO ORDER PNR PRODUCTS

Model	Capacity	Material	Construction	Version
926	L01A	XX	Y	Z

Order example: 926 L01A T1 ST

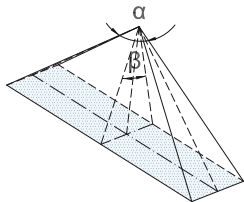

CAPACITY - DIMENSIONS AND WEIGHTS

α	β	Code	Capacity - lpm							Weight g	
			Pressure - bar								
			1,0	2,0	3,0	4,0	5,0	6,0	7,0	10	T1
90°	30°	926 L01A T1ST	3,64	5,14	6,30	7,27	8,13	8,91	9,62	11,50	280
		926 L02A T1ST	9,30	13,15	16,10	18,59	20,79	22,77	24,59	29,39	
		926 L03A T1ST	10,39	14,70	18,00	20,78	23,24	25,46	27,50	32,86	
		926 L04A T1ST	12,41	17,55	21,50	24,83	27,76	30,41	32,84	39,25	

CONVERSION TABLE (UE - USA)

PRESSURE: 1 bar = 14,5 psi

CAPACITY: 1 lpm = 0,264 gpm

FAN JET NOZZLE TIPS

SIZE 3/8" AND 3/4"

These fan jet nozzle tips are usually assembled onto a manifold through a welding nipple or a clamp and secured tight with a locknut. Therefore they can be easily replaced and their jet easily oriented in the desired direction. The tips shown on this page have the most common capacity values. The precisely machined orifice can be protected from clogging through a filter housed inside the nipples and the clamp specifically designed for this purpose. The high capacity nozzle tips, see table below, do not require a filter as they have a large orifice and are assembled with a 3/4" welding nipple. Tips with higher capacities and bigger size than those shown in this catalogue, as well as their related nipples and locknuts, can be produced on request.



SPRAY ANGLE CODE

A	0°	Q	60°
F	30°	U	90°
M	45°	W	120°

MATERIALS CODE

B1	Stainless steel AISI 303
B31	Stainless steel AISI 316 L
T1	Brass

SPRAY DISTRIBUTION

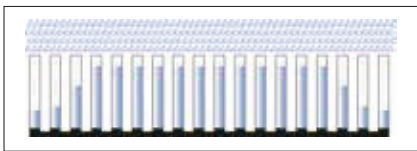

SPRAY PATTERN



HOW TO ORDER PNR PRODUCTS

Model	Spray Angle	Capacity	Material
GX	Q	1190	XX

Order example: **GXQ 1190 T1**

ASSEMBLY FITTING CODING

Size inch	Locknut	Welding nipple	Threaded nipple
3/8"	VAA 0380 xxB	ZAA 1738 xx	ZLA 3838 xx
3/4"	VAA 0750 xxB	ZAA 2775 xx	ZLA 7575 xx

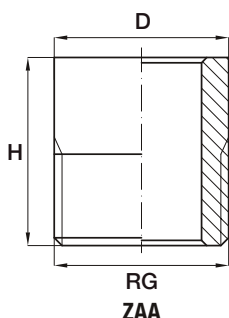
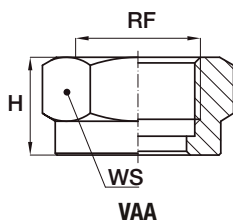
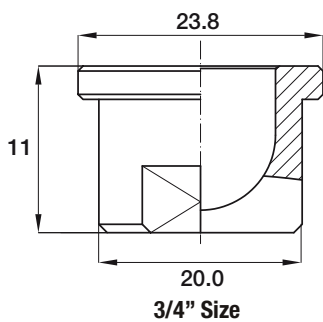
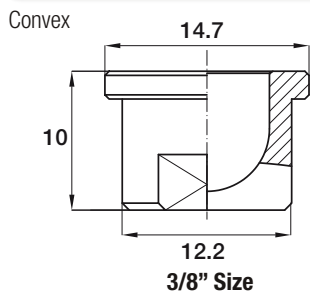

TYPICAL COMBINATION OF A NOZZLE TIP WITH NIPPLE AND LOCKNUT.

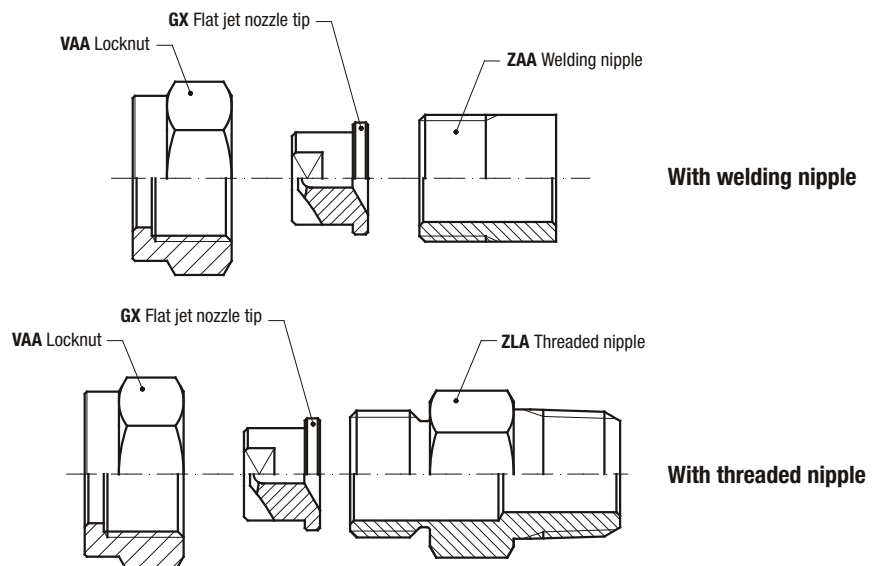

DIMENSIONS

Code	RG/RF inch	D mm	H mm	WS mm
VAA 0380 xxB	3/8"	-	13	22
VAA 0750 xxB	3/4"	-	16	32
ZAA 1738 xx	3/8"	17	18	-
ZAA 2775 xx	3/4"	27	27	-

3/8" size nozzle tips

CAPACITY - WEIGHTS

GXF	GXM	GXQ	GXU	GXW	Code	Capacity - lpm										Weight g	
						Pressure - bar										B31/B1	T1
						0,5	1,0	1,5	2,0	3,0	4,0	5,0	7,0	10			
•	•	•	•	•	1190	0,78	1,10	1,34	1,55	1,90	2,19	2,45	2,90	3,47	8	9	
•	•	•	•	•	1233	0,95	1,35	1,65	1,90	2,33	2,69	3,01	3,56	4,25	8	9	
•	•	•	•	•	1310	1,27	1,79	2,19	2,53	3,10	3,58	4,00	4,74	5,66	8	9	
•	•	•	•	•	1385	1,57	2,22	2,72	3,14	3,85	4,45	4,97	5,88	7,03	8	9	
•	•	•	•	•	1490	2,00	2,83	3,46	4,00	4,90	5,66	6,33	7,48	8,95	8	9	
•	•	•	•	•	1581	2,37	3,35	4,11	4,74	5,81	6,71	7,50	8,87	10,6	8	9	
•	•	•	•	•	1780	3,18	4,50	5,52	6,37	7,80	9,01	10,1	11,9	14,2	8	9	
•	•	•	•	•	1980	4,00	5,66	6,93	8,00	9,80	11,3	12,7	15,0	17,9	8	9	
•	•	•	•	•	2124	5,06	7,16	8,77	10,1	12,4	14,3	16,0	18,9	22,6	8	9	
•	•	•	•	•	2153	6,25	8,83	10,8	12,5	15,3	17,7	19,8	23,4	27,9	8	9	
•	•	•	•	•	2194	7,96	11,3	13,8	15,9	19,5	22,52	25,2	29,8	35,6	8	9	
•	•	•	•	•	2245	10,0	14,1	17,3	20,0	24,5	28,29	31,6	37,4	44,7	8	9	

3/4" size nozzle tips

CAPACITY - WEIGHTS

GXF	GXM	GXQ	GXU	GXW	Code	Capacity - lpm										Weight g	
						Pressure - bar										B31/B1	T1
						0,5	1,0	1,5	2,0	3,0	4,0	5,0	7,0	10			
•	•	•	•	•	1781	3,18	4,50	5,52	6,37	7,80	9,01	10,1	11,9	14,24	23	25	
•	•	•	•	•	1981	4,00	5,66	6,93	8,00	9,80	11,3	12,7	15,0	17,89	23	25	
•	•	•	•	•	2125	5,06	7,16	8,77	10,1	12,4	14,3	16,0	18,9	22,64	23	25	
•	•	•	•	•	2154	6,25	8,83	10,8	12,5	15,3	17,7	19,8	23,4	27,93	23	25	
•	•	•	•	•	2195	7,92	11,2	13,7	15,8	19,4	22,4	25,0	29,6	35,42	23	25	
•	•	•	•	•	2246	10,0	14,1	17,3	20,0	24,5	28,3	31,6	37,4	44,73	23	25	
•	•	•	•	•	2311	12,7	17,9	21,9	25,3	31,0	35,8	40,0	47,4	56,60	23	25	
•	•	•	•	•	2490	20,0	28,3	34,6	40,0	49,0	56,6	63,3	74,8	89,46	23	25	
•	•	•	•	•	2610	24,9	35,2	43,1	49,8	61,0	70,4	78,8	93,2	111,4	23	25	
•	•	•	•	•	2760	31,0	43,9	53,7	62,1	76,0	87,8	98,1	116,1	138,8	23	25	
•	•	•	•	•	3122	49,8	70,4	86,3	99,6	122	141	158	186	223	23	25	

CONVERSION TABLE (UE - USA)

PRESSURE: 1 bar = 14,5 psi

CAPACITY: 1 lpm = 0,264 gpm

FAN JET NOZZLE TIPS WITH DOVE TAIL

SIZE 3/8" AND 3/4"

These fan jet nozzle tips are usually assembled onto a manifold through a welding nipple or a clamp and secured tight with a locknut. Therefore they can be easily replaced and their jet easily oriented in the desired direction. The tips shown on this page have the most common capacity values. The precisely machined orifice can be protected from clogging through a filter housed inside the nipples and the clamp specifically designed for this purpose. The high capacity nozzle tips, see table below, do not require a filter as they have a large orifice and are assembled with a 3/4" welding nipple. Tips with higher capacities and bigger size than those shown in this catalogue, as well as their related nipples and locknuts, can be produced on request.



SPRAY DISTRIBUTION

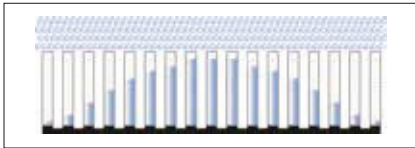

S: Convex (Standard)

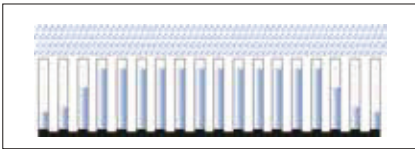

E: Equal

SPRAY PATTERN

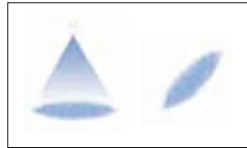

MATERIALS CODE

B1	Stainless steel AISI 303
B31	Stainless steel AISI 316 L
T1	Brass

OFFSET ANGLE: Y

O	+ 0°	A	+ 5°
B	+ 10°	C	+ 15°
D	+ 20°	E	+ 25°
G	+ 35°	J	+ 45°

VERSION: Z

- **S** Standard (Convex distribution)
- **E** Equal distribution

SPRAY ANGLE CODE

F	30°	U	90°
M	45°	W	120°
Q	60°		

HOW TO ORDER PNR PRODUCTS

Model	Spray Angle	Capacity	Material	Version	Offset angle
GY	Q	1190	XX	Z	Y

Order example: GYQ 1190 T1 SBA

ASSEMBLY FITTINGS

Typical set of dove tail nozzle tip with nipple and locknut.

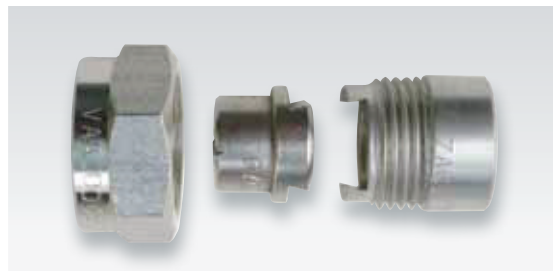

Welding nipples

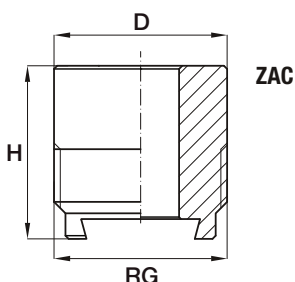
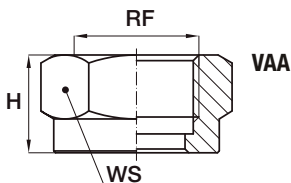
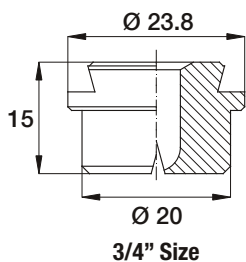
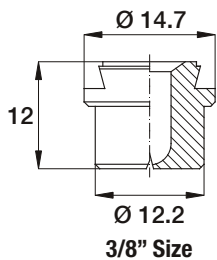

ASSEMBLY FITTING CODING

Size inch	Locknut	Welding nipple
3/8"	VAA 0380 xxB	ZAC 1738 xx
3/4"	VAA 0750 xxB	ZAC 2775 xx

Locknuts and threaded nipples are standard available in:

- Thread BSPP - EN 10226
- Other thread standard upon request

DIMENSIONS

Code	RG/RF inch	D mm	H mm	WS mm
VAA 0380 xxB	3/8"	-	13	22
VAA 0750 xxB	3/4"	-	16	32
ZAC 1738 xx	3/8"	17	18	-
ZAC 2775 xx	3/4"	27	27	-

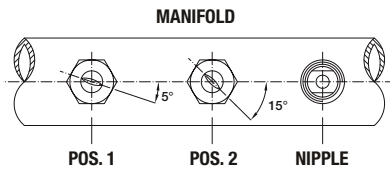

Standard offset angle values
for 3/8" (POS. 1)
and 3/4" (POS. 2) GY tips

In case a different offset angle is required, please refer to " Offset angle" table - Pag 30.

3/8" size nozzle tips

CAPACITY - WEIGHTS

GYF	GYM	GYQ	GYU	GYW	Code	Capacity - lpm										Weight g	
						Pressure - bar										B31/B1	T1
						0,5	1,0	1,5	2,0	3,0	4,0	5,0	7,0	10			
•	•	•	•	•	1190	0,78	1,10	1,34	1,55	1,90	2,19	2,45	2,90	3,47	10	11	
•	•	•	•	•	1233	0,95	1,35	1,65	1,90	2,33	2,69	3,01	3,56	4,25	10	11	
•	•	•	•	•	1310	1,27	1,79	2,19	2,53	3,10	3,58	4,00	4,74	5,66	10	11	
•	•	•	•	•	1385	1,57	2,22	2,72	3,14	3,85	4,45	4,97	5,88	7,03	10	11	
•	•	•	•	•	1490	2,00	2,83	3,46	4,00	4,90	5,66	6,33	7,48	8,95	10	11	
•	•	•	•	•	1581	2,37	3,35	4,11	4,74	5,81	6,71	7,50	8,87	10,6	10	11	
•	•	•	•	•	1780	3,18	4,50	5,52	6,37	7,80	9,01	10,1	11,9	14,2	10	11	
•	•	•	•	•	1980	4,00	5,66	6,93	8,00	9,80	11,3	12,7	15,0	17,9	10	11	
•	•	•	•	•	2124	5,06	7,16	8,77	10,1	12,4	14,3	16,0	18,9	22,6	10	11	
•	•	•	•	•	2153	6,25	8,83	10,8	12,5	15,3	17,7	19,8	23,4	27,9	10	11	
•	•	•	•	•	2194	7,96	11,3	13,8	15,9	19,5	22,52	25,2	29,8	35,6	10	11	
•	•	•	•	•	2245	10,0	14,1	17,3	20,0	24,5	28,29	31,6	37,4	44,7	10	11	

OFFSET ANGLE

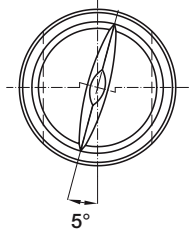

3/4" size nozzle tips

CAPACITY - WEIGHTS

GYF	GYM	GYQ	GYU	GYW	Code	Capacity - lpm										Weight g	
						Pressure - bar										B31/B1	T1
						0,5	1,0	1,5	2,0	3,0	4,0	5,0	7,0	10			
•	•	•	•	•	1781	3,18	4,50	5,52	6,37	7,80	9,01	10,1	11,9	14,2	35	38	
•	•	•	•	•	1981	4,00	5,66	6,93	8,00	9,80	11,3	12,7	15,0	17,9	35	38	
•	•	•	•	•	2125	5,06	7,16	8,77	10,1	12,4	14,3	16,0	18,9	22,6	35	38	
•	•	•	•	•	2154	6,25	8,83	10,8	12,5	15,3	17,7	19,8	23,4	27,9	34	37	
•	•	•	•	•	2195	7,92	11,2	13,7	15,8	19,4	22,4	25,0	29,6	35,4	34	37	
•	•	•	•	•	2246	10,0	14,1	17,3	20,0	24,5	28,3	31,6	37,4	44,7	33	36	
•	•	•	•	•	2311	12,7	17,9	21,9	25,3	31,0	35,8	40,0	47,4	56,6	32	35	
•	•	•	•	•	2490	20,0	28,3	34,6	40,0	49,0	56,6	63,3	74,8	89,5	32	35	
•	•	•	•	•	2610	24,9	35,2	43,1	49,8	61,0	70,4	78,8	93,2	111	27	31	
	•	•			2760	31,0	43,9	53,7	62,1	76,0	87,8	98,1	116	139	25	28	
	•	•			3122	49,8	70,4	86,3	99,6	122	141	158	186	223	23	25	

OFFSET ANGLE

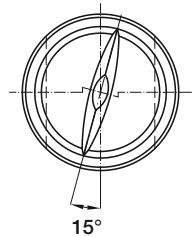

CONVERSION TABLE (UE - USA)

PRESSURE: 1 bar = 14,5 psi

CAPACITY: 1 lpm = 0,264 gpm

H PRESSURE WASHING

HIGH PRESSURE WASHING

Fan jet nozzles F series are designed for high-pressure washing applications. Their special inner profile produce an even spray distribution for an effective and uniform cleaning action over the surface to treat. All nozzles are precisely machined and made of hardened stainless steel AISI 416.



SPRAY ANGLE CODE			
A	0°	L	40°
B	15°	R	65°
D	25°		

MATERIALS CODE	
C2	Hardened Stainless Steel AISI 416

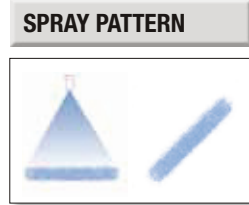
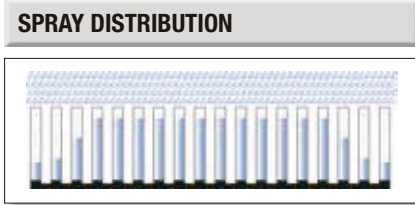

HOW TO ORDER PNR PRODUCTS				
Model	Thread	Spray Angle	Capacity	Material
F	A	D	1460	C2
<i>Order example: FAD 1460 C2</i>				

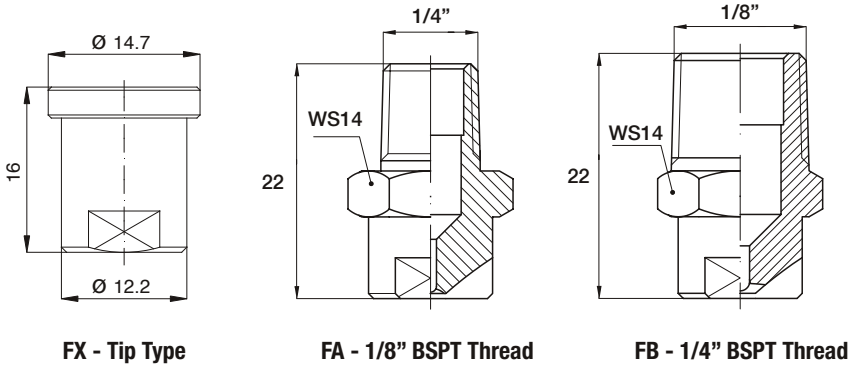

Flow straightener
 We can also supply on request our FX tips which are complete with an inside stainless steel flow straightener to help improve jet efficiency.

THREAD CODE

CAPACITY AND WEIGHTS

THREAD CODE																CAPACITY AND WEIGHTS										
0°			15°			25°			40°			65°			Code	D mm	Capacity - lpm						Weight g			
FX	FA	FB	FX	FA	FB	FX	FA	FB	FX	FA	FB	FX	FA	FB			Pressure - bar						FX	FA	FB	
																20	30	50	70	100	150	200				
								•			•				1460	0,70	1,97	2,41	3,11	3,70	4,40	5,39	6,22	10	14	19
								•			•				1686	1,12	2,95	3,61	4,67	5,50	6,60	8,08	9,33	10	14	19
	•			•				•			•				1930	1,28	4,11	5,04	6,51	7,70	9,20	11,3	13,0	10	14	19
	•			•		•	•	•	•	•	•				2103	1,35	4,61	5,64	7,28	8,60	10,3	12,6	14,6	10	14	19
•	•	•	•	•	•	•	•	•	•	•	•	•			2116	1,42	5,10	6,24	8,06	9,50	11,4	14,0	16,1	10	14	19
•	•	•	•	•	•	•	•	•	•	•	•	•	•		2126	1,47	5,63	6,90	8,91	10,50	12,6	15,4	17,8	10	14	19
•	•	•	•	•	•	•	•	•	•	•	•	•	•	•	2138	1,54	6,08	7,45	9,62	11,40	13,6	16,7	19,2	10	14	19
•	•	•	•	•	•	•	•	•	•	•	•	•	•	•	2149	1,60	6,66	8,16	10,5	12,50	14,9	18,2	21,1	10	14	19
•	•	•	•	•	•	•	•	•	•	•	•	•	•	•	2160	1,66	7,16	8,76	11,3	13,40	16,0	19,6	22,6	10	14	19
•	•	•	•	•	•	•	•	•	•	•	•	•	•	•	2170	1,71	7,60	9,31	12,0	14,20	17,0	20,8	24,0	10	14	19
•	•	•	•	•	•	•	•	•	•	•	•	•	•	•	2181	1,76	8,09	9,91	12,8	15,10	18,1	22,2	25,6	10	14	19
•	•	•	•	•	•	•	•	•	•	•	•	•	•	•	2204	1,87	9,08	11,1	14,4	17,10	20,3	24,9	28,7	10	14	19
•	•	•	•	•	•	•	•	•	•	•	•	•	•	•	2226	1,98	10,1	12,4	16,0	18,90	22,6	27,7	32,0	10	14	19
•	•	•	•	•	•	•	•	•	•	•	•	•	•	•	2341	2,40	15,2	18,7	24,1	28,40	34,1	41,8	48,2	10	14	19
	•			•				•							2456	2,76	20,3	24,9	32,1	38,20	45,4	55,6	64,2	10	14	19
				•				•							2682	3,42	30,4	37,2	48,0	57,10	67,9	83,2	96,0	10	14	19



A GLOBAL PRESENCE ALL OVER THE WORLD.

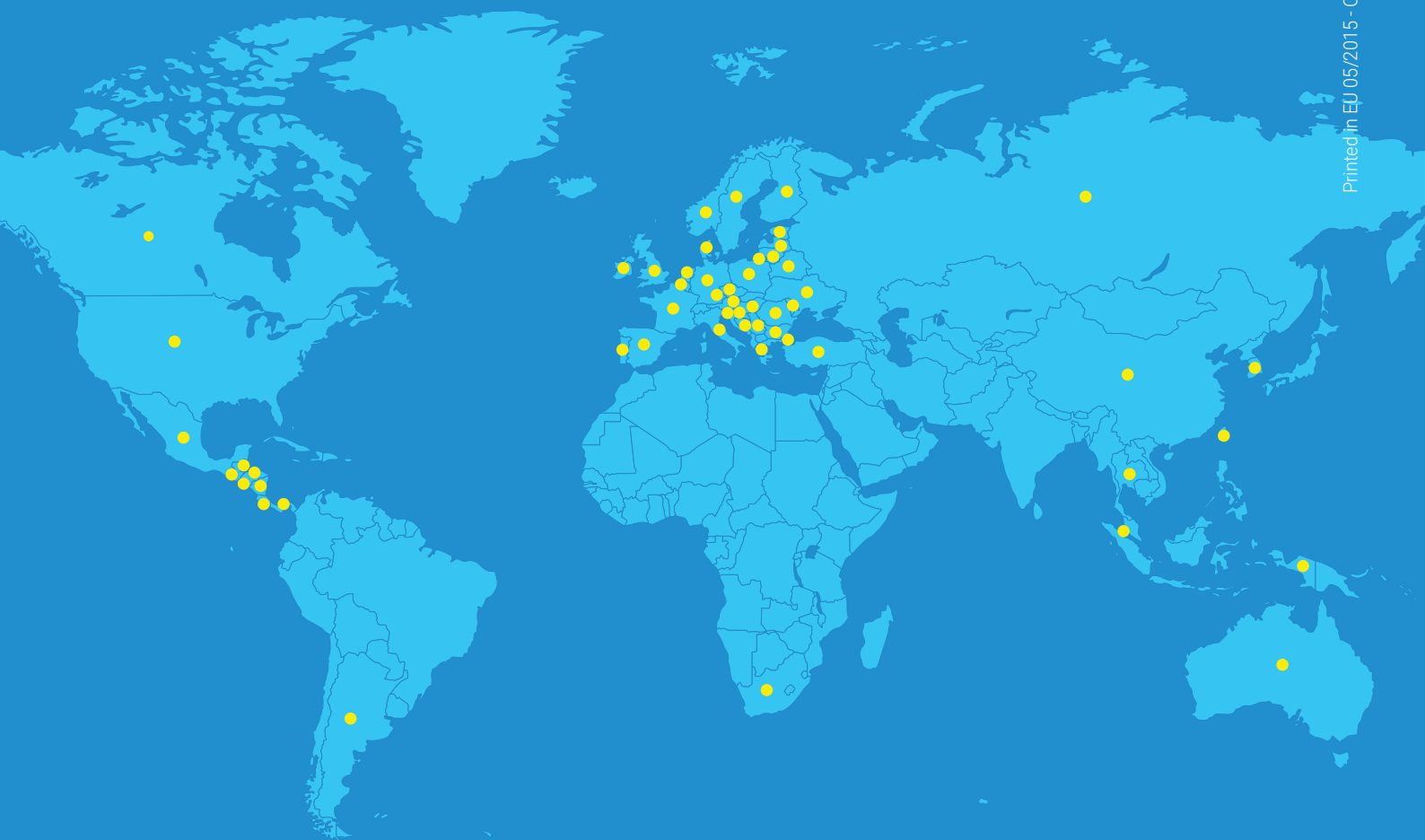

Printed in EU 05/2015 - CTG SW1 EN - ©PNR Italia, all rights reserved



HEADQUARTERS:

PNR Italia srl Via Nenni/Gandini 27058 Voghera (PV) Italia

Phone +39 0383 344 611 Fax +39 0383 212 489

Email info@pnr.it For more info, visit www.pnr.eu

