



SPRAY NOZZLES FOR INDUSTRIAL APPLICATIONS



AIR ASSISTED ATOMIZERS

INTRODUCTION

INDEX

Pagina

Air assisted atomizing and atomizer	1
Properties of an atomized spray	2
Ultrasonic atomizers	3
Atomizing cart	5
Classic atomizers	6
Atomizing set-ups and atomizer code	7
Atomizing systems layout	8
Body styles and atomizer options	9
Pressure atomizers - internal mix	12
Siphon atomizers	15
Pressure atomizers - external mix	16
Large size atomizers	18
Accessories	21
Special atomizers	23
Hydraulic atomizers	24

TECHNICAL PUBLICATIONS

PNR manufactures a complete range of spray nozzles for industrial applications, as well as products and systems specially designed for specific industries. Information about our Company and our product range is available through the following publications

SPRAY NOZZLES & ASSEMBLY FITTINGS	CTG GN
INDUSTRIAL TANK WASHING SYSTEMS	CTG LS
AIR ASSISTED ATOMIZERS	CTG AZ
SPRAY ENGINEERING HANDBOOK	CTG SH
STEELWORK NOZZLES	CTG SW
SOLUTIONS FOR THE PULP AND PAPER INDUSTRY	CTG PN

As a result of continuous product improvement our documentation is regularly updated: please visit our website to be always updated.

NOTES

Our products are continuously being reviewed and modified to keep up with the latest state of technology. As a result the technical information provided in this catalogue is for guidance only and is not binding. We regret not being able to provide our customers with notification of such changes all of the time. Should you have an application that requires some special features such as specific flow rates or spray angles for example, then please issue a written request before sending your order and we'll do our best to meet your requirements. All information contained in this catalogue, including product data, product codes, diagrams and photographs are the exclusive property of Flowtech. It is forbidden to reproduce any part of this catalogue without having obtained written permission from Flowtech first.

Dimensions in this catalogue are given in millimetres (mm). All threads are made according to the ISO 228 standards (European norms BS 2779 – DIN 259 – UNI 338). Explanations about the abbreviations used in the catalogue are given on page 25. All mentioned Trademarks are the property of their respective owners.

Our Company has qualified its quality system with DNV, following ISO 9001/2015 standard.

**COMPANY WITH
QUALITY SYSTEM
CERTIFIED BY DNV GL
= ISO 9001:2015 =**

INTRODUCTION

AIR ASSISTED ATOMIZING

Several industrial processes need the atomizing of liquids into fine and very fine droplets.

This result might be achieved by means of a purely hydraulic nozzle, with the liquid being fed at high pressure through a very small orifice, but the process would originate two main problems:

- A Requiring costly investments and complicated lay-out.
- B Originating plugging problems because of the small orifice dimensions.

In the majority of industrial processes a fine liquid atomization is obtained by means of air assisted atomizers, where compressed air supplies the required energy to break the liquid and to throw the droplets at a given distance from the atomizer. An air atomizing system has however two inherent limitations:

- A The narrow inside passages require adequate filtering of air and liquid.
- B The high speed jet will only produce narrow angle sprays. To overcome this inconvenience multiple orifice atomizers are used to produce a diverging sprays with better droplet distribution.

AIR ASSISTED ATOMIZERS

The first two sections of the Catalog show two types of atomizers largely used in the industry, the third one deals with complete atomizing systems.

ULTRASONIC ATOMIZERS

These devices provide liquid atomization in two steps:

- A The liquid is injected into the nozzle center and is first atomized by shear action and then mixed with the high speed air stream leaving the nozzle through the outlet orifice.
- B The stream carrying the droplets is taken to impact onto a resonator placed in front of the nozzle orifice, and generates a field of sound waves for additional droplet breakup.

Ultrasonic atomizers produce very fine droplets, in a tight dimensional range, and supply low capacities below 100 liters per hour. Their operation produces a typical noise, the level of which needs to be checked according to the local regulations if some personnel is supposed to work in a nearby area.

CLASSIC ATOMIZERS

These devices produce liquid atomization by simple shear action, providing a high velocity stream to impact onto a liquid flow. In spite of their inherent low efficiency, and because of the low capacities involved, classic atomizers are the most convenient solution for most of the current applications. A wide range of spray patterns, capacities, atomizer types, body options and accessories has been developed to suit many different requirements from the industry.

PNR MATERIAL CODES

Many products in this Catalog are available in different materials, and therefore the product codes carry often two letters (XX) which need to be replaced from the required material code. A list with the most used codes is given in the following.

A1	Mild steel
A2	High speed steel
A8	Zinc plated steel
A9	Nickel plated steel
B1	AISI 303 Stainless steel
B2	AISI 304 Stainless steel
B21	AISI 304 L Stainless steel
B3	AISI 316 Stainless steel
B31	AISI 316 L Stainless steel
B8	AISI 309 Stainless steel
C2	AISI 416, Hardened SS
D1	Polyvinylchloride (PVC)
D2	Polypropylene (PP)

D3	Polyamide (PA)
D5	Polypropylene, w/talcum
D6	Polypropylene, 25% glass fiber
D7	High Density Polyethylene
D8	Polyvinyliden fluoride (PVDF)
E0	EPDM
E1	Ethylenepolytetrafluor. (PTFE)
E3	Acetalic resin (POM)
E31	DELRIN ®
E6	LUCITE ® (PMMA)
E7	Viton
E8	Synthetic rubber (NBR)
H1	Titanium

L1	Monel 400
L2	Incolloy 825
L8	Hastelloy
P6	Acrylic but. styrene (ABS)
P8	EPDM, 40 Shore
T1	Brass
T2	Chrome plated brass
T3	Copper
T8	Nickel plated brass
T81	ENP Brass
T9	Brass body, Stainless steel set-up
V1	Aluminum
V7	ENP Aluminum

INTRODUCTION

PROPERTIES OF A LIQUID SPRAY

The atomization of a liquid by means of a compressible fluid, like air, steam or a gas, is defined two-phase or twin-fluid or pneumatic atomization. Many industrial processes require using finely atomized droplets and the techniques to produce finely atomized sprays have been largely improved in recent years with new types of atomizers being developed.

In addition more sophisticated process techniques have increased the demand for a precise definition about the characteristics of a given spray for the purpose of getting precisely repeatable results. The most interesting parameters defining a given spray have been defined as in the following, and are now available to the process design engineer.

Arithmetic Mean Diameter AMD (D10)	This is the arithmetic Mean Value as calculated on the diameters from the total number of the drops in the sample spray.
Volume Mean Diameter VMD (D30)	This is the diameter of that drop whose volume is the arithmetic mean from the total number of the drops in the sample spray.
Sauter Mean Diameter SMD (D32)	This is the diameter of that drop whose Volume/Surface ratio is the arithmetic mean from the total number of the drops in the sample spray.

The following Histograms and Diagrams are often used to resume the data referring to the above parameters and give a visual definition of a spray:

- Volume percentage cumulative diagram
- Droplet diameter distribution Histogram
- Droplet velocity distribution Histogram

The dimensional parameters and the above information make it possible to base process calculations on precise data atomization degree, efficiency of heat exchange and spray behavior in a given operation ambient. The knowledge of a value for the Sauter Mean Diameter SMD (D32) in a given spray is of special importance for the calculation of heating exchange in evaporative cooling processes, since it makes it possible to know the value of the total heat exchange surface obtained atomizing a known quantity of liquid.

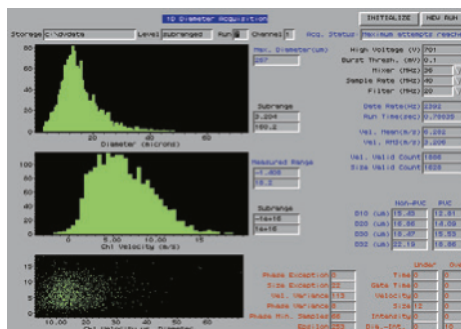

PNR can supply upon request complete documentation containing test reports about the aforementioned parameters for all PNR catalog and special atomizers.

The Histograms beside show the distribution of droplet diameters (D32) and velocities for one spray obtained in our laboratory.

The photo beside shows a test performed in our laboratory. A laser Interferometer is used to measure and record the spray parameters, while fluid flow rates and feed pressures are monitored with high precision instruments.

NOTE

Please note that all capacity values given in this catalog refer to test performed using water and compressed air. Atomizing liquids other than water, or using motive fluids different from compressed air will modify the performance of any atomizer, which have to be assessed through a laboratory test.



ULTRASONIC ATOMIZERS

Ultrasonic atomizers operate on a very sophisticated process which is based on two steps: In the first one tiny water jets are injected into an high speed air flow which provides a first break up and atomization of the fluid. In the second step the two phase flow, air entraining liquid droplets, goes trough a field of sound waves which produce a further break up and a lower droplet dimension. This is realized through an impact between the two phase flow and a resonator located in front of the nozzle orifice.

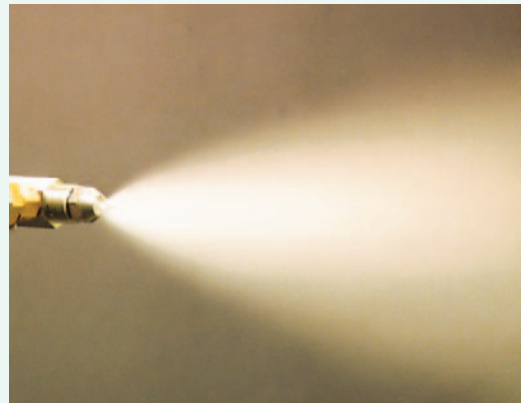

Ultrasonic atomizers can only be manufactured with high precision machining operations but offer the following remarkable advantages.

A

The droplets in the atomized jet show low values for the Sauter Mean Diameter, and in addition a rather narrow range of individual droplet diameter: in other words the drops are very small and with little difference in diameter between the smallest and the biggest droplet. This means the spray is made by droplets very small and very similar in size, which is very important in all evaporative processes like for example air humidification: it is rather easy then to obtain values for the evaporation time and evaporation length of a given spray.

B

The noticeable variations in local air pressure all around the resonator, associated to the sound waves, eliminate the danger of dust and foreign particles build-up in the vicinity of the nozzle orifice, thus avoiding a decay in the atomizer performance.

The system will then be very reliable and require limited or null maintenance.

Ultrasonic atomizers



Page 4

Atomizing carts



Page 5

ULTRASONIC ATOMIZERS

ATOMIZERS AND FITTINGS

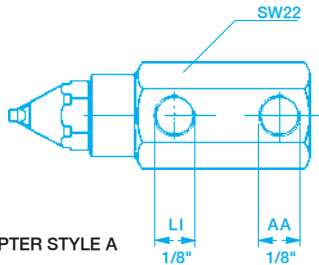

ADAPTER STYLE A

Ultrasonic atomizers produce the finest sprays available with air assistance for industrial processes, with a narrow angle full cone jet. Water and air do not mix in a confined volume before leaving the nozzle and therefore their feed pressures can be adjusted independently without influencing each other: this allows for a very wide regulation range on the liquid capacity and makes it easier to reach the desired operating conditions.

Please note that the code given in the table only refers to the atomizing head and must be completed with the identification for one of the four connection adapters available, as shown below in the page. The drawing beside shows an atomizing head assembled onto one A type adapter.

Materials
 Atomizing head B1 AISI 303 Stainless steel
 Adapter B1 AISI 303 Stainless steel
 T1 Brass

WM = Water capacity (l/min)
 AH = Air capacity (Nmc/ora)

IDENTIFICATION CODES

ATOMIZING HEAD
 The codes given in the table refer to the atomizing head only, and can be used to order the head as a separate part.

ADAPTERS
 Can be ordered separately using the codes below, please replace
 XX = B1 for AISI 303
 XX = T1 for brass

COMPLETE ATOMIZERS
 To identify a complete atomizer, please add to the head code the three suffix letters describing the potential adapter style and its material, according to the information below.

MAD 0801 B1 X Y Z

Adapter material
 A = T1 Brass
 B = B1 AISI 303

Adapter style
 A = XMA 0103 xx
 B = XMA 0101 xx
 C = XMA 0102 xx
 D = XMA 0100 xx

Connection
 G = BSP F
 N = NPT F

Code		Air pressure (bar)										
		0,5		0,7		1,0		2,0		3,0		
		WM	AH	WM	AH	WM	AH	WM	AH	WM	AH	
25°	MAD 0331 B1	2	0,10	3,1	0,12	3,0	0,15	3,1	0,27	2,7	-	-
		3	0,05	3,7	0,10	3,1	0,12	3,6	0,20	3,7	0,32	2,9
		4	0,02	4,7	0,05	4,8	0,08	4,4	0,18	4,4	0,25	4,2
		5	-	-	0,02	5,3	0,05	5,3	0,13	5,5	0,22	5,2
		6	-	-	-	-	0,02	6,1	0,12	6,0	0,18	5,8
		6	-	-	-	-	-	-	-	-	-	-
	MAD 0801 B1	2	0,23	2,7	0,28	2,9	0,37	2,7	0,72	2,2	-	-
		3	0,22	3,6	0,27	3,6	0,32	3,5	0,52	3,2	0,82	2,7
		4	0,18	4,5	0,22	4,4	0,28	4,6	0,45	4,6	0,62	4,7
		5	0,12	5,4	0,18	5,3	0,25	5,6	0,40	5,4	0,53	5,4
		6	0,07	6,2	0,13	6,3	0,22	6,2	0,35	6,3	0,50	6,2
		6	-	-	-	-	-	-	-	-	-	-
	MAD 1131 B1	2	0,50	7,3	0,60	6,6	0,73	6,9	1,15	5,6	-	-
		3	0,40	9,7	0,50	9,5	0,65	9,4	0,96	9,3	1,35	7,9
		4	0,27	11,6	0,37	11,9	0,55	11,8	0,93	12,1	1,20	11,5
		5	0,13	13,9	0,23	13,8	0,38	14,0	0,87	14,1	1,15	13,8
		6	0,07	18,6	0,13	18,7	0,27	18,7	0,72	18,9	1,10	19,0
		6	-	-	-	-	-	-	-	-	-	-
40°	MAL 0800 B1	2	0,18	2,7	0,23	2,7	0,32	2,9	0,73	2,1	-	-
		3	0,15	3,7	0,18	3,9	0,25	3,5	0,50	3,7	0,85	2,6
		4	0,10	4,5	0,17	4,6	0,22	4,9	0,33	4,8	0,53	4,4
		5	0,03	5,4	0,10	5,6	0,18	5,4	0,30	5,4	0,45	5,3
		6	-	-	0,03	6,2	0,12	6,3	0,27	6,2	0,38	6,3
		6	-	-	-	-	-	-	-	-	-	-
	MAL 1130 B1	2	0,46	7,3	0,52	7,2	0,68	6,8	1,13	5,7	-	-
		3	0,38	9,5	0,47	9,7	0,65	10,2	0,95	9,4	1,27	7,7
		4	0,23	11,8	0,35	11,8	0,50	11,9	0,88	12,1	1,15	11,8
		5	0,13	13,5	0,23	13,9	0,37	14,0	0,82	14,1	1,10	14,2
		6	0,07	16,0	0,13	16,2	0,27	16,2	0,63	16,2	1,03	16,3
		6	-	-	-	-	-	-	-	-	-	-
	MAL 1300 B1	2	0,95	14,6	1,12	16,5	1,40	16,3	2,42	10,4	-	-
		3	0,80	19,3	1,00	20,0	1,26	22,2	1,90	19,2	2,87	14,5
		4	0,60	24,7	0,80	24,7	1,08	25,0	1,80	25,0	2,40	23,2
		5	0,42	29,9	0,60	30,3	0,90	30,4	1,70	30,5	2,27	29,9
		6	0,23	35,6	0,40	36,0	0,67	35,6	1,55	36,2	2,15	35,2
		6	-	-	-	-	-	-	-	-	-	-

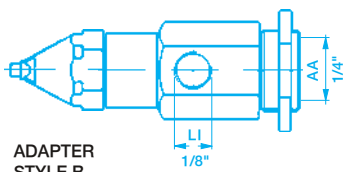

ADAPTER STYLE B

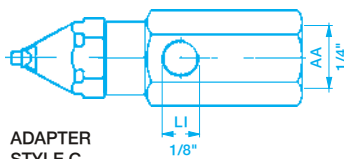

ADAPTER STYLE C

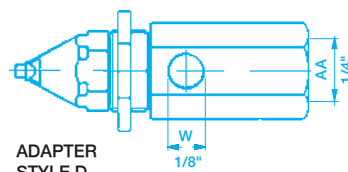

ADAPTER STYLE D

LOCKNUT FITS BOTH FRONT AND REAR THREADED BODIES.

B and D adapter style allow for mounting the atomizer through a wall or the side of a duct. In this case do not forget to order the VAM 2002 xxA locknut, which fits both, to hold the adapter in place.

ATOMIZING CARTS

ATOMIZING CARTS

This type of atomizing cart makes it possible to atomize into the air of confined rooms liquids without requiring an operator to be present, the typical example being spraying disinfectants in hospital rooms.

These devices combine the ease of mobility with long operation times and can be efficiently operated by all kind of personnel after a very simple training.

The solution to be atomized is contained into the stainless steel tank, where it is put under pressure by means of the same compressed air used for the atomization process and which must be available on the spot.

Up to three atomizers for a maximum capacity of 7,2 l/min can be assembled onto the cart, each of them mounted on a swivel head for efficient ambient saturation. Ease of mobility is assured from two rubber lined wheels and a convenient handle.

The device can be operated with simple manual controls, or from a PLC unit which allows for setting an operation time and a start delay for allowing the operator to leave the room before atomizing starts.

Weight with manual control 13 kg (empty)

Tank volume 19 liters

Atomizing carts are designed on customer requirements, therefore no standard range coding is available. A certificate according to EUROPEAN 97/23/CE (PED) norm is released for each tank.



CLASSIC ATOMIZERS



Classic atomizers are devices producing an atomized spray with the assistance of compressed air, where the liquid is broken into droplets when its outer surface is subjected to shear action from the high speed air flow. By assembling together a range of standard components in different materials, several different capacity values, spray patterns, spray angles and operation modes can be obtained. In addition, specific application problems can be addressed by the use of special accessories available on request.



Page 7

ATOMIZER SET-UP

The set-up is the device where air and liquid flow come in contact and produce the atomized jet.

It consists of a liquid nozzle and an air nozzle, hose orifice dimensions are combined in several different ways in order to obtain the capacity, the spray pattern and the spray angle required.

The above spray parameters are given in the performance tables, besides each set-up code.



Page 8

ATOMIZER BODIES

The atomizer body serves the purpose of conveniently connecting the set-up to the feed lines for air and water, and it may include some options like liquid shut-off or orifice cleaning needles.

In addition to the MW type, the standard body, a more complete MX type includes an air operated cylinder for remote control of spray operation.



Page 21

ACCESSORIES AND OPTIONS

In addition to the standard range of components some specific requirements like resistance to internal erosion or solid build-up from water borne foreign matters, body options with a different design or different spray control procedures, can be addressed with special parts.

CLASSIC ATOMIZERS

SPRAY SET-UP

A spray set-up is made out of a liquid nozzle and an air nozzle. When assembled the air nozzle fits precisely onto the liquid nozzle and the combination of the two provides the correct inside geometry to produce the spray. Such parameters of the two parts as the number, dimensions and profile of their inside passages determines all the characteristics of the atomized spray produced by that given set-up. A set-up can be selected according to the choices beside.

The capacity tables in the following catalog pages show the specification of each individual set-up, that is air and liquid capacities as a function of air and liquid feed pressures, and spray dimensions. Spray dimensions are understood measured in still air for several pressure values, and cannot be precisely defined, therefore we give indicative values of the maximum throw and of the distance for which the spray maintains a consistent shape.

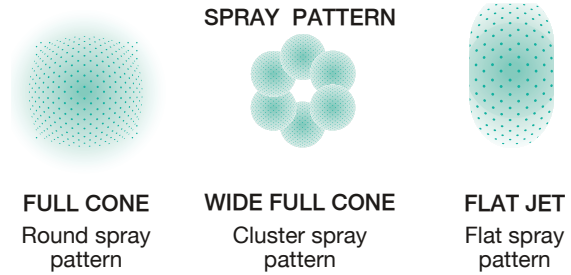

OPERATION PRINCIPLE	Internal mix	Page 8
	External mix	
LIQUID FEED	Pressure feeding	Page 8
	Siphon feeding	

SET-UP PARTS

The set-up code, complete with the material code, can be used to order air and liquid nozzle together. Under the set-up code, air (An) and liquid nozzle (Ln) codes are shown separately for ordering them as spare parts, while Teflon seal and locknut can be ordered with the codes shown beside.

All PNR components are made interchangeable and can be combined even if made in different materials, like for example assembling an erosion resistant set-up in stainless steel with a brass body.

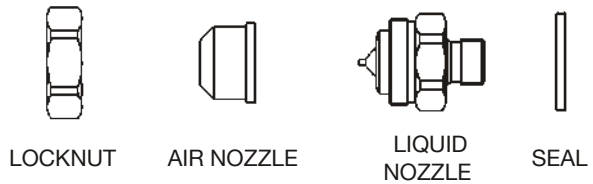

VAM 1901 xx

VDA 0981 E1*

Set-up code	SUB 1520
Ln XMW 5001xx	Liquid nozzle code
An XMW 4001xx	Air nozzle code

* Standard seal is in Teflon; on request, we can provide:
 - copper (VDA 0981 T3);
 - Viton (VDA 0981 E7);
 - AISI 316L (VDA 0981 B31).

COMPLETE ATOMIZER CODE

Once the set-up code (and therefore the spray characteristics, has been chosen) it is necessary to choose the body and the options required to come to the complete atomizer code. A set-up can be assembled basically on two different body types:

BASIC BODY

This body serves the only purpose of connecting the set-up inlets to the air and liquid feed lines. The plug on the body top can be replaced by several option equipment as shown next page

AIR ACTUATED BODY

This body has a built in air cylinder allowing to start and stop the spray from a remote location. Additional options are shown at page 10 and 21

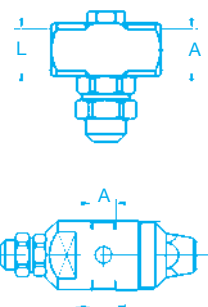

CLASSIC ATOMIZERS

ATOMIZER FEEDING

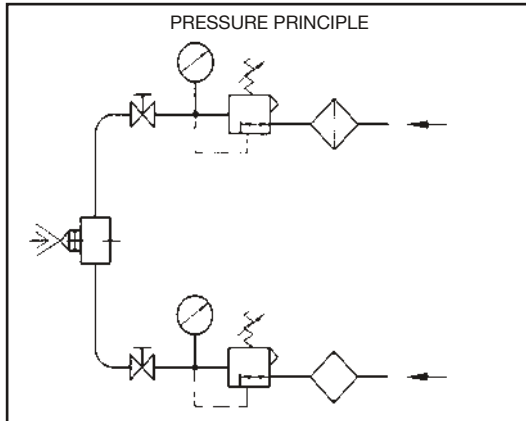

An atomizer can work on two different liquid feed principles, that is

- Liquid is supplied to the atomizer through a line under pressure
- Liquid is aspirated by the atomizer from a container at ambient pressure.

PRESSURE PRINCIPLE

It is the most widely used, and therefore a large range of capacities and spray patterns are available. Liquid capacity, air capacity and droplet sizes can be adjusted by regulating air and liquid feed pressures and the two fluids are mixed inside the atomizer prior to be ejected (Internal mix atomizers).

A different type allows for mixing the fluids just after they are ejected from the orifice, avoiding mutual influence of the two fluid pressure values inside a mixing chamber and allowing wider regulation range (External mix atomizers).

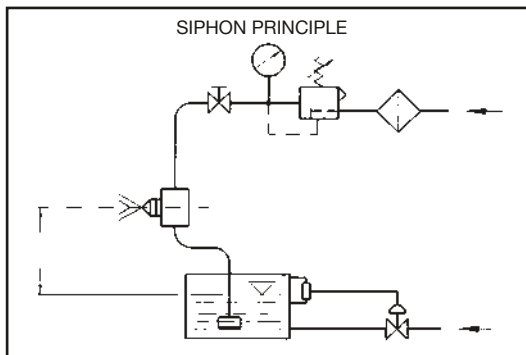

SIPHON PRINCIPLE

These atomizers offer lower capacity values for liquids and a simpler layout since the liquid is aspirated from the atomizer through a Venturi effect. The liquid is simply supplied from an open container, whose level can be lower or higher than the atomizer one to fine tune the liquid capacity. The atomizing air provides the vacuum necessary into the mixing chamber for the Venturi effect.

SPRAY GENERATION

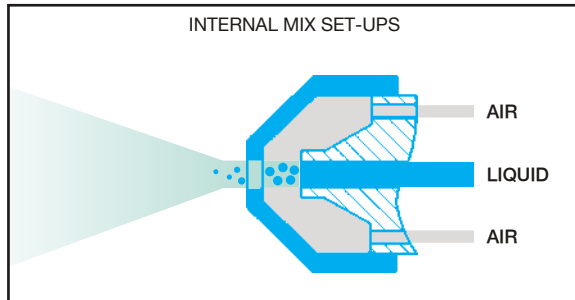

The set-up can be designed in two different ways so as to obtain the following actions

- Air and liquid are mixed up in a mixing chamber inside the atomizer and then they are ejected through the orifice as a spray.
- Air and liquid are ejected from the atomizer through different orifices, and the spray is generated by the impact of the two jets.

INTERNAL MIX SET-UPS

The spray is ejected from one or more orifices in the wall of a mixing chamber. In these atomizers a change in the pressure of one of the fluids inside the mixing chamber has an influence on the capacity of the second fluid and this effect reduces the ease of regulation. As an example, increasing the air pressure will decrease the liquid quantity being atomized and the droplet size, and vice-versa.

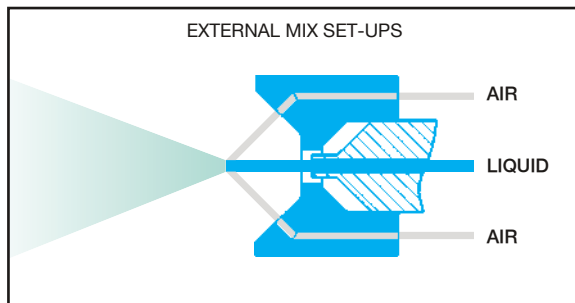

EXTERNAL MIX SET-UPS

The two fluids are ejected through different orifices, their mixing happens outside the orifice. Therefore their pressure values can be adjusted avoiding cross influence with a more precise and stable regulation. External mix set-ups can only work with liquid feed under pressure, and only produce flat jet spray.

1/4" SIZE **CLASSIC ATOMIZERS**

BODY TYPES AND OPTIONS

MW

COMPLETE CODE

To obtain the complete code for an atomizer it is necessary to use the set-up code you have chosen from the performance table and complete it with the code for body and options as follows:

- Replace the first two letters in the set-up code (SU) with the code for standard body (MW).
- Add the code for the material you require.
- Add the code for the required options, if any, and the thread type code.

MWB 1520 X Y Z



MATERIALS

B1 = AISI 303 Stainless steel
B31 = AISI 316L Stainless steel
D1 = PVC
E6 = LUCITE® (PMMA)
T8 = Nickel plated brass

CONNECTION

G = BSP Female (EU)
N = NPT Female (US)

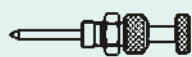
OPTIONS

A		BASIC BODY
B		SHUT-OFF NEEDLE
C		CLEANING NEEDLE
D		CLEAN AND SHUT-OFF NEEDLE

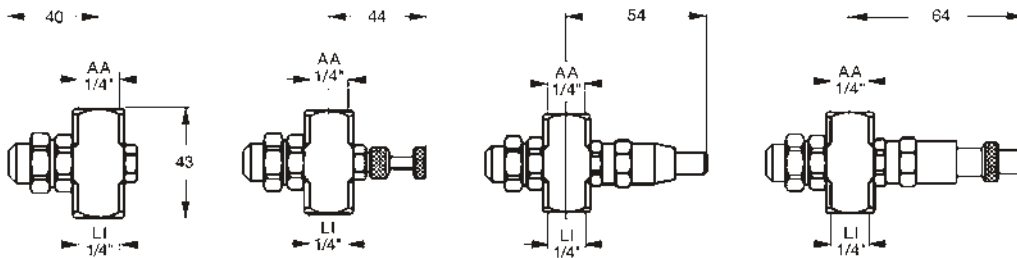

AA = Air Inlet (1/4" F)
 LI = Liquid inlet (1/4" F)

CLASSIC ATOMIZERS

MX

BODY TYPES AND OPTIONS

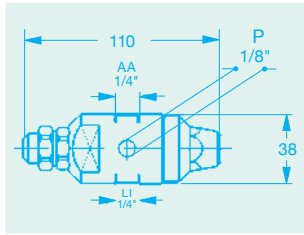

STANDARD SIZE

AA = atomizing air inlet (1/4" F)
 LI = liquid inlet (1/4" F)
 AC = cylinder air inlet (1/8" F)

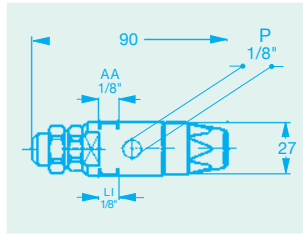

MINI SIZE

AA = atomizing air inlet (1/8" F)
 LI = liquid inlet (1/8" F)
 AC = cylinder air inlet (1/8" F)

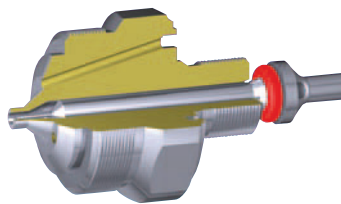

COMPLETE CODE

To obtain the complete code for an atomizer it is necessary to use the set-up code you have chosen from the performance table and complete it with the code for body and options as follows.

- Replace the first two letters in the set-up code (SU) with the code for air actuated body (MX).
- Add the code for the material you require.
- Add the code for the required options and the code for thread type

AIR ACTUATED ATOMIZER

MX bodies contain an air actuated cylinder which controls the spray operation by means of a needle, opening or closing the water inlet in the liquid nozzle.

Normally the air used for atomizing the liquid flows continuously, while the air to the actuator is used to start and stop the atomizing cycles.

For longer idle times between two atomizing cycles, where too much atomizing air would be wasted, sequenced shut-off should be organized for the two air lines.

The actuator air should be stopped (and the liquid flow interrupted) before atomizing air to be sure all liquid inside is completely atomized and dripping is avoided.

Conversely, when spray begins, atomizing air should be started first so that incoming liquid is atomized without dripping.

Single air option is shown at page 21

NO-DRIP NEEDLE

Our engineers have invented, developed and introduced on the market a no-drip needle (Italian Patent MI96U-00541) to assure positive liquid shut-off and completely drip-free operation.

This solved completely the old problem of dripping atomizers as offered from our competitors. All air actuated PNR atomizers include this better and more consistent design as standard

MXB 1520 X YY Z

MATERIALS

B1 = AISI 303 Stainless steel
 B31 = AISI 316L Stainless steel
 T8 = Nickel plated brass

CONNECTION

G = BSP Female (EU)
 N = NPT Female (US)

OPTIONS	Shut-off needle	Cleaning needle
Standard	SA	SB
Mini	MA	MB
Standard single air inlet	UA	UB
Mini single air inlet	NA	NB

PRESSURE PRINCIPLE

1/4" SIZE

INTERNAL MIX SET-UPS

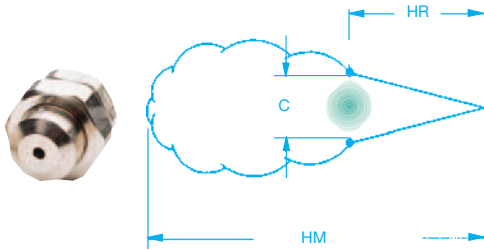

WH = Water capacity (l/ora)

AM = Air capacity (NI/min)

FULL CONE SPRAY

These single orifice set-ups produce narrow angle, full cone shaped, atomized sprays with a spray angle of about 20°.

More precise details on the spray dimensions are given in the table on the right side of the page.

The spray length can reach from 2.500 to 9.000 mm depending upon the set-up type and operating conditions.

See advice on adjustment for flow rates and droplet size given at page 8.

Materials

B1 AISI 303 Stainless steel

B31 AISI 316L Stainless steel

D1 PVC

E6 LUCITE® (PMMA)

T8 Nickel plated brass

Set-up code	Air pressure (bar)																
	0,7		1,0		1,5		2,0		3,0		4,0		PA	PL	HR	C	HM
	WH	AM	WH	AM	WH	AM	WH	AM	WH	AM	WH	AM					
SUB 1520	0,7	2,5	15,6	1,4	6,4	13,9	2,7	6,2	23,0	3,5	7,8	28,0	-	-	-	-	-
	0,9	1,8	19,0	1,7	5,5	16,7	2,8	5,7	25,0	3,7	7,3	29,0	0,9	0,7	300	68	2700
	1,0	1,4	22,0	2,0	4,5	19,8	3,0	5,2	27,0	3,9	6,4	33,0	1,7	1,5	330	75	3000
	-	-	-	2,2	3,4	24,0	3,1	4,7	29,0	4,2	5,5	38,0	2,5	2,0	360	82	3400
	Ln XMW 5001	-	-	-	2,4	3,0	26,0	3,2	4,3	31,0	4,5	4,5	43,0	3,1	3,0	390	96
An XMW 4001	-	-	-	2,5	2,5	28,0	3,4	3,9	33,0	4,6	4,1	45,0	4,5	4,0	440	116	4400
-	-	-	2,7	2,3	31,0	3,7	3,0	38,0	4,8	3,7	47,0	-	-	-	-	-	-
SUB 1670	0,7	2,5	18,7	1,7	6,7	29,0	2,2	9,2	34,0	2,8	11,9	39,0	-	-	-	-	-
	0,9	2,0	22,0	1,8	6,4	31,0	2,5	8,2	39,0	3,1	11,0	43,0	0,9	0,7	430	90	3700
	1,0	1,6	26,0	2,0	5,9	34,0	2,8	7,2	44,0	3,4	10,1	47,0	1,5	1,5	460	105	4000
	-	-	-	2,1	5,2	37,0	3,0	6,7	47,0	3,7	9,2	52,0	2,4	2,0	480	109	4300
	Ln XMW 5001	-	-	-	2,2	4,8	40,0	3,1	6,3	49,0	3,9	8,4	58,0	3,0	3,0	510	116
An XMW 4002	-	-	-	2,4	4,3	43,0	3,2	5,9	52,0	4,2	7,6	62,0	3,9	4,0	560	147	5200
-	-	-	2,7	3,6	48,0	3,4	5,5	55,0	4,5	6,8	68,0	-	-	-	-	-	-
SUB 2142	0,9	4,8	21,0	2,0	10,7	33,0	2,7	16,5	37,0	3,4	20,0	43,0	-	-	-	-	-
	1,1	4,1	27,0	2,1	9,8	37,0	2,8	15,4	38,0	3,7	18,4	47,0	1,5	0,7	480	100	4000
	1,4	3,4	33,0	2,4	8,2	42,0	3,1	13,6	43,0	3,9	16,8	50,0	2,5	1,5	510	116	4300
	1,5	3,1	35,0	2,7	6,8	48,0	3,4	11,8	49,0	4,2	15,2	55,0	3,0	2,0	530	120	4600
	Ln XMW 5002	1,7	3,0	39,0	3,0	5,9	55,0	3,7	10,4	55,0	4,5	13,8	60,0	3,4	3,0	560	137
An XMW 4002	1,8	2,9	41,0	3,2	5,0	59,0	3,9	9,1	61,0	4,8	12,4	65,0	4,2	4,0	600	158	5300
-	2,0	2,8	44,0	3,5	4,1	65,0	4,2	7,9	65,0	4,9	11,8	68,0	-	-	-	-	-
SUC 2376	1,1	13,0	76,0	2,8	20,0	136	3,4	32,0	149	4,6	37,0	193	-	-	-	-	-
	1,4	8,9	91,0	3,1	16,3	149	3,9	25,0	170	5,3	29,0	220	1,7	0,7	660	209	4900
	1,5	7,2	98,0	3,4	11,9	163	4,6	15,9	205	5,6	25,0	235	2,8	1,5	760	268	6100
	1,7	5,8	105	3,9	7,0	187	5,3	9,1	240	6,0	21,0	250	3,9	2,0	810	286	6700
	Ln XMW 5003	1,8	4,7	112	4,2	4,7	205	5,6	6,8	255	6,3	17,4	270	5,3	3,0	910	337
An XMW 4003	2,0	3,6	119	4,6	3,0	220	6,0	5,0	275	6,7	14,0	290	6,0	4,0	970	359	9100
-	2,1	2,7	127	-	-	-	6,3	3,6	290	7,0	11,0	305	-	-	-	-	-
SUC 2690	0,9	31,0	57,0	2,1	53,0	96,0	2,7	80,0	103	3,8	88,0	135	-	-	-	-	-
	1,0	25,0	66,0	2,4	41,0	112	3,0	69,0	117	4,2	73,0	156	1,0	0,7	610	182	4900
	1,1	18,5	75,0	2,7	31,0	127	3,2	59,0	130	4,6	61,0	176	1,8	1,5	690	218	5800
	1,3	12,9	85,0	2,8	26,0	136	3,5	49,0	146	4,9	48,0	196	2,8	2,0	760	268	6700
	Ln XMW 5004	-	-	-	3,0	22,0	144	3,7	44,0	154	5,3	39,0	215	3,5	3,0	790	278
An XMW 4003	-	-	-	-	-	-	3,8	37,0	161	5,6	31,0	240	4,9	4,0	910	337	8500
-	-	-	-	-	-	-	3,9	35,0	170	6,0	23,0	260	-	-	-	-	-
SUC 3129	1,0	44,0	86,0	2,0	123	108	2,2	199	88,0	3,0	250	99,0	-	-	-	-	-
	1,1	32,0	102	2,1	108	119	2,5	174	110	3,2	225	120	1,0	0,7	890	298	6100
	-	-	-	2,2	95,0	130	2,8	146	133	3,5	205	141	1,7	1,5	990	349	7000
	-	-	-	2,4	79,0	143	3,1	121	154	3,8	182	163	2,4	2,0	1040	385	7600
	Ln XMW 5005	-	-	-	2,5	64,0	155	3,2	108	166	4,1	159	184	3,1	3,0	1070	396
An XMW 4004	-	-	-	2,7	52,0	166	3,4	95	176	4,6	121	225	3,8	4,0	1170	455	9100
-	-	-	2,8	42,0	178	3,5	84	187	4,9	93,0	255	-	-	-	-	-	-

0,7

2,0

3,0

4,0

Liquid pressure (bar)

1/4" SIZE **PRESSURE PRINCIPLE**

INTERNAL MIX SET-UPS

WIDE ANGLE FULL CONE SPRAY

These multi-orifice set-ups produce wide angle, full cone shaped, atomized sprays as a result from the combination of several narrow angle sprays.

The resulting encompassed spray angle is about 60° and more precise details on the spray dimensions are given in the table on the right side of the page.

The spray length can reach from 1.500 to 10.400 mm depending upon the set-up type and operating conditions. See advice on adjustment for flow rates and droplet size given at page 8.

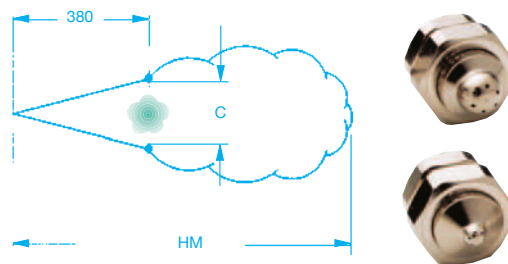

WH = Water capacity (l/ora)
AM = Air capacity (NI/min)

- Materials**
- B1** AISI 303 Stainless steel
 - B31** AISI 316L Stainless steel
 - D1** PVC
 - T8** Nickel plated brass

Set-up code	Air pressure (bar)																
	0,7		1,5		2,0		3,0		4,0		PA	PL	C	HM			
	WH	AM	WH	AM	WH	AM	WH	AM	WH	AM							
SUL 1640	0,6	5,3	10,2	1,5	8,1	16,4	2,4	8,9	22,0	3,1	10,5	24,0	0,7	0,7	230	1500	
	0,7	4,3	12,2	1,8	6,6	21,0	2,7	8,1	26,0	3,4	9,7	28,0	1,4	1,5	240	1800	
	0,9	3,0	14,2	2,1	4,9	25,0	3,0	6,4	30,0	3,9	7,8	36,0	1,8	2,0	250	2100	
	1,0	1,7	17,0	2,4	3,2	29,0	3,2	4,9	34,0	4,2	6,1	42,0	3,0	3,0	260	2700	
	Ln XMW 5001	-	-	-	-	-	-	3,4	4,2	37,0	4,6	4,4	47,0	3,9	4,0	300	4000
An XMW 4010	-	-	-	-	-	-	3,5	3,4	40,0	4,9	2,8	54,0	-	-	-	-	
SUM 2220	0,9	7,0	50,0	2,0	18,5	68,0	2,8	25,0	84,0	3,7	31,0	96,0	-	-	-	-	
	1,0	2,1	62,0	2,1	15,1	76,0	3,0	22,0	92,0	3,8	28,0	105	0,9	0,7	310	1800	
	-	-	-	2,2	11,7	85,0	3,1	18,5	101	3,9	26,0	113	1,7	1,5	330	2400	
	-	-	-	-	-	-	3,2	15,1	109	4,1	23,0	122	2,1	2,0	330	3200	
	Ln XMW 5003	-	-	-	-	-	-	3,4	12,1	119	4,2	20,0	130	3,2	3,0	340	4100
An XMW 4011	-	-	-	-	-	-	3,5	9,1	130	4,6	13,6	153	4,1	4,0	370	5900	
-	-	-	-	-	-	-	3,7	6,1	142	4,9	6,8	183	-	-	-	-	
SUL 2330	1,1	12,3	40,0	2,7	21,0	69,0	4,2	19,3	100	5,6	22,0	130	-	-	-	-	
	1,3	9,9	45,0	3,0	16,3	78,0	4,6	14,6	113	6,0	17,6	142	1,5	0,7	230	2700	
	1,4	7,9	50,0	3,2	12,3	86,0	4,9	10,8	124	6,3	14,0	152	3,0	1,5	240	4600	
	1,5	6,1	54,0	3,4	10,7	91,0	5,3	8,1	135	6,7	11,4	163	3,4	2,0	240	5500	
	1,7	4,9	58,0	3,5	9,3	94,0	5,6	6,2	146	7,0	9,1	174	5,3	3,0	250	7300	
	1,8	3,9	62,0	3,9	6,4	105,0	6,0	4,9	157	-	-	-	6,3	4,0	300	9400	
	An XMW 4013	2,0	3,1	67,0	4,2	4,7	115,0	6,3	4,0	167	-	-	-	-	-	-	-
	-	-	-	-	-	-	-	-	-	-	-	-	-	-	-	-	-
SUM 2460	0,7	24,0	32,0	2,1	33,0	66,0	2,8	52,0	65,0	3,7	63,0	68,0	-	-	-	-	
	0,9	13,6	44,0	2,2	26,0	78,0	3,0	46,0	76,0	3,8	58,0	79,0	0,9	0,7	360	2100	
	1,0	7,6	57,0	2,4	18,9	89,0	3,1	39,0	87,0	3,9	52,0	101	1,5	1,5	370	3200	
	-	-	-	2,5	11,7	100	3,2	33,0	99,0	4,2	41,0	111	2,4	2,0	370	4100	
	Ln XMW 5004	-	-	-	-	-	-	3,4	26,0	110	4,6	27,0	138	3,2	3,0	380	5000
An XMW 4011	-	-	-	-	-	-	3,5	19,5	122	4,9	15,9	166	3,9	4,0	390	6800	
-	-	-	-	-	-	-	3,7	13,2	133	-	-	-	-	-	-	-	
SUM 2860	1,3	36,0	85,0	3,1	53,0	156	4,2	64,0	197	5,6	74,0	245	-	-	-	-	
	1,5	29,0	102	3,2	50,0	163	4,9	51,0	230	6,0	68,0	260	2,0	0,7	330	5500	
	1,8	23,0	117	3,4	47,0	170	5,6	40,0	265	6,3	62,0	280	3,0	1,5	340	6400	
	2,0	19,7	125	3,5	45,0	177	6,0	34,0	285	6,7	56,0	295	3,9	2,0	370	8200	
	2,1	16,7	133	3,9	38,0	194	6,3	28,0	300	7,0	51,0	315	6,0	3,0	380	9100	
	2,3	14,0	142	4,6	25,0	230	6,7	22,0	320	-	-	-	6,3	4,0	410	10400	
	An XMW 4012	2,4	11,4	149	4,9	18,5	245	7,0	17,8	335	-	-	-	-	-	-	-
SUQ 3140	1,7	25,0	156	3,4	50,0	250	4,6	62,0	320	6,0	93,0	395	2,0	0,7	460	5500	
	1,8	19,7	167	3,5	43,0	260	4,9	47,0	345	6,3	77,0	425	3,2	1,5	470	6400	
	2,0	15,1	178	3,7	41,0	275	5,3	36,0	375	6,7	62,0	460	3,9	2,0	510	7300	
	2,1	11,4	193	3,9	27,0	300	5,6	26,0	405	7,0	52,0	495	5,3	3,0	530	7900	
	2,3	7,6	205	4,1	23,0	310	6,0	18,9	435	-	-	-	6,3	4,0	580	9800	
	Ln XMW 5005	-	-	-	4,2	18,9	320	6,3	13,6	460	-	-	-	-	-	-	-
	An XMW 4014	-	-	-	4,4	15,9	335	-	-	-	-	-	-	-	-	-	-

0,7

2,0

3,0

4,0

Liquid pressure (bar)

PRESSURE PRINCIPLE

1/4" SIZE

INTERNAL MIX SET-UPS

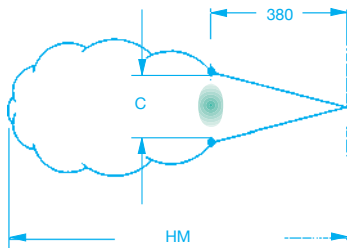

FLAT SPRAY

These single orifice set-ups produce flat fan shaped atomized sprays. More precise details on the spray dimensions are given in the table on the right side of the page.

The spray length can reach from 1.800 to 5.200 mm depending upon the set-up type and operating conditions.

See advice on adjustment for flow rates and droplet size given at page 8.

WH = Water capacity (l/ora)
AM = Air capacity (NI/min)

Materials
B1 AISI 303 Stainless steel
B31 AISI 316L Stainless steel
D1 PVC
T8 Nickel plated brass

Set-up code	Air pressure (bar)																
	0,7		2,0		3,0		4,0		5,0		6,0		PA	PL	C	HM	
	WH	AM	WH	AM	WH	AM	WH	AM	WH	AM	WH	AM					
SUU 2101	0,7	5,5	24	2,0	8,6	42	2,7	11,2	52	3,9	12	69	1,1	0,7	460	2600	
	0,9	4,7	27	2,2	7,5	47	3,0	10,1	56	4,6	9,7	81	2,1	1,5	660	3000	
	1,0	4,1	31	2,5	6,2	52	3,2	9,1	62	5,3	7,5	93	2,8	2,0	760	3200	
	1,1	3,5	34	2,8	5,2	57	3,5	8,1	66	6,0	5,3	104	3,5	3,0	860	3400	
	1,3	3,0	37	3,1	4,2	63	4,2	5,4	79	6,3	4,3	110	6,0	4,0	940	4000	
	Ln XMW 5001 An XMW 4020	1,4	2,5	40	3,2	3,7	65	4,6	4,2	85	6,7	3,3	116	-	-	-	-
	1,5	2,0	44	3,4	3,2	68	4,9	3,1	91	7,0	2,4	122	-	-	-	-	
SUU 2160	1,3	3,9	30	3,0	6,1	52	3,9	9,4	60	5,3	10,2	78	1,5	0,7	460	1800	
	1,4	3,0	33	3,1	5,3	54	4,2	7,2	67	5,6	8,3	84	2,7	1,5	690	2000	
	1,5	2,3	35	3,2	4,5	57	4,6	5,3	73	6,0	6,6	89	3,2	2,0	910	2000	
	1,7	1,8	38	3,4	3,8	59	4,9	3,8	80	6,3	5,1	98	4,2	3,0	940	2100	
	Ln XMW 5002 An XMW 4022	1,8	1,3	41	3,5	3,2	62	-	-	-	-	-	5,6	4,0	970	2300	
		2,0	1,0	44	3,9	1,8	68	-	-	-	-	-	-	-	-	-	-
SUM 2167	1,0	9,0	25	2,4	11,6	48	3,1	15,6	56	4,2	17,1	73	1,4	0,7	170	3000	
	1,1	7,8	30	2,5	10,4	51	3,2	14,6	59	4,6	15	80	2,5	1,5	200	3700	
	1,3	6,6	32	2,7	9,40	54	3,4	13,7	62	4,9	12,8	87	3,2	2,0	220	4000	
	1,4	5,2	36	3,0	7,30	61	3,8	10,8	71	5,3	11	94	3,8	3,0	280	4200	
	Ln XMW 5002 An XMW 4021	1,7	3,1	44	3,2	5,50	68	4,2	8,5	82	5,6	9,4	103	5,3	4,0	330	4800
		2,0	2,0	50	3,5	4,10	75	4,9	5,2	98	6,3	7,2	119	-	-	-	-
	2,2	1,1	56	3,8	2,90	81	6,0	2,3	120	7,0	6,1	134	-	-	-	-	
SUU 2171	0,9	8,2	20	2,1	13,5	36	2,7	19,1	42	4,6	16,1	69	1,1	0,7	710	2100	
	1,0	6,8	23	2,4	11,4	42	3,0	17,1	46	4,9	13,8	76	2,1	1,5	810	2400	
	1,1	5,5	27	2,7	9,20	47	3,2	15,1	52	5,3	11,5	83	3,0	2,0	890	2600	
	1,3	4,1	30	3,0	7,10	53	3,5	13,1	57	5,6	9,3	90	3,5	3,0	970	2700	
	Ln XMW 5002 An XMW 4020	1,4	2,9	34	3,2	5,00	59	4,2	8,1	72	6,0	7,3	97	5,6	4,0	970	3200
		-	-	-	3,4	4,00	63	4,6	5,9	79	6,3	5,6	104	-	-	-	-
	-	-	-	3,5	3,30	66	4,9	4,0	86	6,7	4,3	112	-	-	-	-	
SUM 2320	1,1	11,2	54	2,7	19,6	93	3,5	27	112	4,6	33	137	1,4	0,7	200	3000	
	1,3	8,5	60	2,8	17,3	98	3,7	25	116	4,9	28	149	2,4	1,5	330	3200	
	1,4	6,5	65	3,0	15,2	103	3,8	23	121	5,3	24	161	3,0	2,0	460	3400	
	1,5	5,0	71	3,1	13,2	109	3,9	21	126	5,6	19,7	174	3,7	3,0	460	3500	
	Ln XMW 5003 An XMW 4024	1,7	3,8	77	3,2	11,4	114	4,1	18,9	132	6,0	15,7	187	5,3	4,0	480	4000
		-	-	-	-	-	-	4,2	17	137	6,3	12,4	200	-	-	-	-
SUM 2600	1,0	17,0	23	2,4	28,0	51	3,4	38	72	3,9	65	75	1,1	0,7	150	2400	
	1,1	11,0	27	2,5	23,0	59	3,5	33	80	4,2	53	89	2,1	1,5	170	3000	
	1,3	7,6	33	2,7	18,9	66	3,7	28	89	4,6	40	108	2,8	2,0	220	3400	
	1,4	3,2	40	2,8	15,1	74	3,8	23	97	4,9	30	127	3,7	3,0	280	3600	
	Ln XMW 5004 An XMW 4023	-	-	-	3,0	11,7	79	3,9	19,7	105	5,3	21	149	4,9	4,0	350	4000
		-	-	-	-	-	-	4,2	13,1	120	5,6	13,8	173	-	-	-	-
	-	-	-	-	-	-	4,6	7,2	138	6,3	3,2	225	-	-	-	-	
SUQ 2700	0,9	27,0	33	2,4	39,0	67	3,2	58	76	4,6	59	106	1,1	0,7	300	3400	
	1,0	20,0	38	2,7	30,0	77	3,5	47	87	5,3	40	132	2,4	1,5	410	3500	
	1,1	15,9	45	3,0	24,0	87	3,8	38	97	5,6	32	145	3,2	2,0	430	3700	
	1,3	12,5	48	3,2	17,8	98	3,9	34	103	6,0	26	158	3,9	3,0	480	3800	
	Ln XMW 5004 An XMW 4024	1,4	10,2	56	3,4	15,1	103	4,2	27	113	6,3	20	172	6,0	4,0	510	4400
		1,5	7,6	62	3,5	12,9	109	4,6	20	126	6,7	15,9	185	-	-	-	-
	-	-	-	3,7	10,6	114	4,9	14,8	140	7,0	12,7	198	-	-	-	-	
SUQ 3126	1,0	29,0	90	2,1	100	119	3,0	126	140	4,1	140	181	1,0	0,7	250	3400	
	1,1	18,9	108	2,2	79,0	133	3,1	110	151	4,2	125	193	1,8	1,5	430	3800	
	-	-	-	2,4	62,0	147	3,2	95	163	4,6	89	225	2,4	2,0	460	4300	
	-	-	-	2,5	48,0	162	3,4	78	184	4,9	58	265	3,4	3,0	530	4600	
	Ln XMW 5005 An XMW 4025	-	-	-	2,7	36,0	177	3,5	62	193	5,3	34	305	4,9	4,0	580	5200
		-	-	-	-	-	-	3,7	48	210	5,6	16,7	340	-	-	-	-
	-	-	-	-	-	-	3,8	37	225	-	-	-	-	-	-	-	

0,7

2,0

3,0

4,0

Liquid pressure (bar)

1/4" SIZE

SIPHON PRINCIPLE

INTERNAL MIX SET-UPS

ROUND AND FLAT SPRAYS

These set-ups are designed to work with a liquid fed out of an ambient pressure container, either by liquid siphoning or by gravity head.

Therefore the performance tables give the water flow rate for both suction head (green background) and gravity head (white background).

The approximate spray depending upon set-up type and operating conditions are given from the table at the right, while advice about adjustment for flow rates and droplet sizes given at page 8.

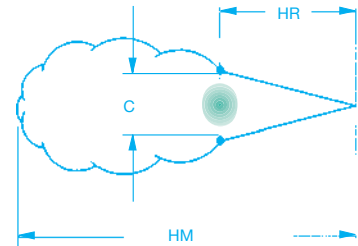

WH = Water capacity (l/ora)
AM = Air capacity (Nl/min)

- Materials
- B1 AISI 303 Stainless steel
 - B31 AISI 316L Stainless steel
 - D1 PVC
 - T8 Nickel plated brass

Set-up code	Air pressure (bar)										Full Cone Spray			
	Air capacity (Nml/min)										PA	HR	C	HM
	Liquid capacity (l/ora)													
SUC 1120	0,7	11	1,5	1,3	1,1	0,9	0,7	0,5	-	-	0,7	280	89	1800
	1,5	17	1,8	1,7	1,5	1,3	1,2	1,1	0,6	-	1,5	280	89	1900
	3,0	28	2,1	1,9	1,7	1,5	1,4	1,3	1,1	0,8	3,0	300	95	2300
	4,0	36	2,2	2,0	1,8	1,6	1,5	1,4	1,2	0,9	4,0	360	114	2600
SUC 1190	0,7	13	2,4	2,1	1,7	1,5	1,2	0,8	-	-	0,7	300	95	2100
	1,5	20	2,8	2,6	2,4	2,1	1,9	1,6	0,9	-	1,5	330	104	2300
	3,0	32	3,4	3,1	2,9	2,8	2,6	2,4	1,7	1,1	3,0	380	120	2600
	4,0	41	3,7	3,4	3,3	3,1	2,9	2,7	2,1	1,5	4,0	430	144	3000
SUC 1200	0,7	23	2,5	2,3	2,0	1,6	1,4	1,1	-	-	0,7	300	95	2400
	1,5	36	2,9	2,8	2,5	2,2	2,0	1,7	0,9	-	1,5	330	104	2700
	3,0	58	3,4	3,3	3,2	2,9	2,8	2,5	1,9	1,2	3,0	380	127	3400
	4,0	74	3,7	3,6	3,5	3,4	3,3	3,0	2,5	2,0	4,0	430	151	4000
SUC 1290	0,7	19	4,5	4,0	3,4	2,1	1,8	1,4	-	-	0,7	380	140	3000
	1,5	31	5,3	4,9	4,4	3,5	2,9	2,7	1,8	-	1,5	410	152	3400
	3,0	50	6,0	5,6	5,0	4,4	4,0	3,4	2,4	1,2	3,0	460	170	4000
	4,0	65	5,7	5,4	5,0	4,2	3,9	3,5	2,8	1,9	4,0	510	198	4600
SUC 2105	1,5	58	22,0	19,9	16,3	12,3	10,5	8,3	2,8	-	1,5	460	137	3700
	3,0	88	25,0	23,0	19,5	16,7	14,2	11,5	6,4	2,8	3,0	510	161	4300
	4,0	111	26,0	24,0	21,0	18,4	15,7	12,9	7,9	4,5	4,0	530	168	4900
	5,6	147	26,0	24,0	22,0	19,7	17,0	14,6	9,8	6,1	5,6	580	194	5500
SUC 2180	2,0	144	-	-	-	27,0	22,0	16,8	-	-	2,0	510	180	6700
	3,0	190	-	-	-	30,0	26,0	21,0	-	-	3,0	530	187	7000
	4,0	240	-	43,0	40,0	31,0	28,0	23,0	11,0	-	4,0	580	215	7600
	5,6	315	44,0	42,0	39,0	31,0	28,0	24,0	16,7	8,3	5,6	630	245	8200

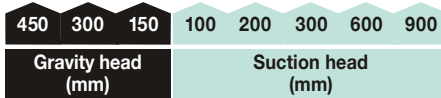

Set-up code	Air pressure (bar)										Flat Fan Spray		
	Air capacity (Nml/min)										PA	C	HM
	Liquid capacity (l/ora)												
SUQ 0860	0,7	28	1,3	1,2	1,1	1,0	1,0	0,8	0,6	0,5	0,7	380	2100
	1,5	43	1,2	1,1	1,0	0,9	0,9	0,8	0,7	0,5	1,5	380	2100
	2,0	50	0,8	0,8	0,7	0,6	0,5	-	-	-	2,0	380	1800
SUQ 1280	1,5	56	3,7	3,5	3,3	2,9	2,8	2,5	2,3	2,1	1,5	380	2700
	2,0	65	3,4	3,3	3,1	2,8	2,7	2,6	2,4	2,2	2,0	420	2700
	3,0	87	2,8	2,7	2,5	2,4	2,2	2,1	1,9	1,7	3,0	460	3000
	4,0	110	1,9	1,8	1,6	1,5	1,3	1,2	-	-	4,0	480	2700
SUQ 1370	1,5	68	5,1	4,8	4,5	3,8	3,7	3,5	3,0	2,4	1,5	270	3400
	2,0	78	4,9	4,7	4,4	3,6	3,4	3,2	2,9	2,3	2,0	280	3400
	3,0	103	3,4	3,2	3,0	2,2	2,0	1,7	-	-	3,0	300	3000
	3,5	117	2,2	2,0	1,7	-	-	-	-	-	-	-	-
SUQ 1540	1,5	63	7,6	7,2	6,6	5,7	5,4	5,1	4,6	3,7	1,5	270	3400
	2,0	73	7,6	7,3	6,8	5,9	5,7	5,5	5,0	4,2	2,0	290	3400
	3,0	96	6,4	6,1	5,7	5,0	4,5	4,1	3,3	-	3,0	330	3400
	3,5	110	4,2	3,7	3,2	2,6	-	-	-	-	-	-	-

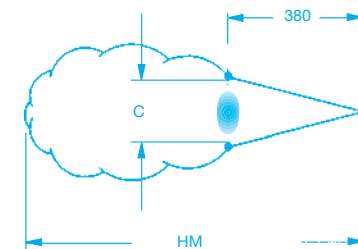
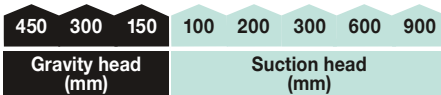

WH = Water capacity (l/ora)
AM = Air capacity (Nl/min)



PRESSURE PRINCIPLE

1/4" SIZE

EXTERNAL MIX

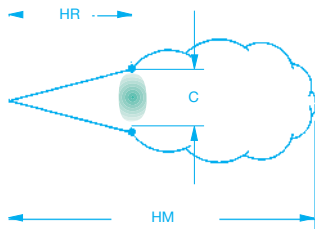

WH = Water capacity (l/ora)
AM = Air capacity (NI/min)

FLAT FAN SPRAY

These set-ups are designed in order to have two different paths for air and liquid, and to eject them through different orifices, so that the atomized spray is produced from their impact in the immediate surroundings of the orifices. It is possible therefore to atomize viscous liquids as well as any liquid which might originate a solid build up in the mixing chamber of an ordinary internal mix atomizer.

In addition liquid and air pressure can be adjusted independently from each other, which allows for an easy steady state atomizer regulation. The approximate spray depending upon set-up type and operating conditions are given from the table at the right, while advice about adjustment for flow rates and droplet sizes given at page 8

Materials

- B1 AISI 303 Stainless steel
- B31 AISI 316L Stainless steel
- D1 PVC
- T8 Nickel plated brass

Set-up code	Air pressure (bar)																						
	WH		AM		WH		AM		WH		AM		WH		AM		PA	PL	C	HM	HR		
SUL 2110	0,2		25	0,4		26	0,7		31	1,1		40	1,8		45	2,8		74	0,2	0,2	230	900	150
	0,4		26	0,7		31	1,1		40	1,8		54	3,5		54	3,5		85	1,1	0,2	230	1200	150
	0,7		31	1,1		40	1,4		45	2,1		54	2,8		60	4,2		102	1,4	0,4	230	1200	150
	1,1	2,8	40	1,4	3,5	45	1,8	5,3	54	2,8	7,8	74	4,9	11	119	1,4	1,4	250	1,4	1,4	250	1500	180
	1,4		45	1,8		54	2,1		59	3,5		85	5,3		85	5,3		128	1,8	0,7	240	1500	150
	1,8		54	2,1		59	2,8		74	4,2		102	5,6		102	5,6		139	2,8	1,4	280	1800	180
Ln XMW 5006 An XMW 4030	2,1		59	2,8		74	3,5		85	5,6		139	6,3		139	6,3		159	4,9	2,8	240	2400	180
SUT 2111	0,4		22	0,4		22	0,4		25	0,6		28	0,7		28	0,7		34	0,6	0,7	400	1800	300
	0,5	2,8	25	0,5	3,5	25	0,6	5,3	28	0,7	7,8	34	1,1	11	45	1,1	45	0,6	1,5	460	1800	350	
	0,5		27	0,6		28	0,7		34	1,1		45	1,8		62	1,4	62	1,4	1,5	410	2700	300	
	0,6		28	0,7		34	0,9		40	1,4		54	2,5		79	1,1	79	1,1	2,0	480	2600	350	
SUR 2166	0,4		26	0,7		31	1,1		40	1,8		54	3,2		54	3,2		82	0,4	0,2	220	1000	140
	0,7		31	1,1		40	1,4		45	2,1		59	3,5		59	3,5		85	1,4	0,2	220	1700	150
	1,1		40	1,4		45	1,8		54	2,8		74	4,2		74	4,2		102	1,8	0,4	230	1800	165
	1,4	4,5	45	1,8	5,5	54	2,1	8,3	59	3,5	12,2	85	4,9	16,6	119	1,8	1,4	290	2,1	0,7	250	2100	190
	1,8		54	2,1		59	2,8		74	4,2		102	5,3		102	5,3		127	2,1	0,7	250	1800	180
	2,1		59	2,8		74	3,5		85	4,9		119	6,3		159	3,5	1,4	300	3,5	1,4	300	2400	220
Ln XMW 5001 An XMW 4030	2,8		74	3,5		85	4,2		102	6,3		159	6,7		159	6,7		164	5,3	2,8	250	3000	190
SUV 2172	0,4		22	0,4		22	0,6		28	0,7		34	1,1		34	1,1		45	0,7	1,5	580	1800	460
	0,6	4,5	28	0,7	5,5	34	0,7	8,3	34	1,4	12,2	54	1,4	17,2	54	1,4	54	1,4	1,5	560	2400	430	
	0,7		34	1,1		45	1,4		54	2,1		71	2,1		71	2,1		71	1,8	2,0	580	2700	460
	1,1		45	1,4		54	2,1		71	2,5		79	2,5		79	2,5		79	1,8	3,0	660	2900	480
SUS 2330	0,7		31	1,1		40	1,4		45	2,5		68	3,5		68	3,5		85	0,7	0,2	250	1200	165
	1,1		40	1,4		45	1,8		54	2,8		74	4,2		74	4,2		102	1,8	0,2	250	1800	165
	1,4		45	1,8		54	2,1		59	3,5		85	4,9		85	4,9		119	2,1	0,4	240	1800	180
	1,8	8,5	54	2,1	10,4	59	2,8	15,9	74	4,2	23	102	5,3	33	127	2,5	1,4	320	2,5	1,4	320	1800	200
	2,1		59	2,8		74	3,5		85	4,9		119	5,6		139	2,8	0,7	300	2,8	0,7	300	2300	190
	2,8		74	3,5		85	4,2		102	5,6		139	6,3		159	4,2	1,4	360	4,2	1,4	360	3000	200
Ln XMW 5002 An XMW 4030	3,5		85	4,2		102	4,9		119	6,3		159	7,0		159	7,0		176	5,3	2,8	300	4000	200
SUV 2331	0,4		25	0,4		25	0,4		25	0,7		34	1,4		34	1,4		54	0,6	0,7	630	1500	480
	0,5	8,5	27	0,6	10,4	28	0,6	15,9	28	0,9	23	40	1,8	33	62	0,7	1,5	630	0,7	1,5	630	1800	480
	0,6		28	0,7		31	0,7		34	1,1		45	2,1		71	1,4	1,5	660	1,4	1,5	660	2400	530
	0,7		34	0,8		34	0,9		40	1,4		54	2,5		79	1,8	2,0	690	1,8	2,0	690	2700	510
SUQ 2520	0,7		85	1,0		102	1,4		116	2,5		178	3,2		178	3,2		212	0,7	0,2	250	1700	190
	1,0		102	1,4		116	1,8		139	2,8		195	3,5		195	3,5		232	1,8	0,2	250	2700	190
	1,4		116	1,8		139	2,1		156	3,5		227	4,2		227	4,2		255	2,1	0,4	280	3000	190
	1,8	13,4	139	2,1	16,4	156	2,5	25	178	4,2	37	266	4,2	52	275	2,5	0,7	280	2,5	0,7	280	3500	220
	2,1		156	2,8		195	2,8		195	4,9		312	4,9		312	4,9		314	2,5	1,4	360	3700	230
	2,8		195	3,5		227	3,5		227	5,6		360	5,6		360	5,6		360	4,2	1,4	370	4300	230
Ln XMW 5007 An XMW 4032	3,5		227	4,2		266	4,2		266	6,3		411	6,3		411	6,3		411	4,9	2,8	320	4900	220
SUV 2521	0,6		91	0,7		102	1,4		156	2,1		210	3,2		210	3,2		285	2,1	0,7	560	4300	400
	0,7	13,4	102	1,1	16,4	130	2,1	25	210	2,8	37	260	4,2	52	360	2,1	1,5	580	2,1	1,5	580	4000	460
	1,1		130	1,8		184	2,5		235	3,5		310	5,3		310	5,3		430	4,2	1,5	640	5200	480
	1,4		156	2,1		210	2,8		260	4,2		360	5,6		360	5,6		455	3,9	2,0	690	4600	510

0,2

0,3

0,7

1,5

3,0

Liquid pressure (bar)

1/4" SIZE **PRESSURE PRINCIPLE**

EXTERNAL MIX

FLAT FAN SPRAY

Set-up code	Air pressure (bar)																			
	WH		AM		WH		AM		WH		AM		WH		AM		PA	PL	C	HM
SUT 2680 Ln XMW 5003 An XMW 4032	0,7		85	1,4		116	1,8		139	2,8		195	3,5		232	0,7	0,4	270	2100	190
	1,0		102	1,8		139	2,1		156	3,2		212	4,2		275	1,8	0,7	270	3000	190
	1,4		116	2,1		156	2,5		178	3,5		227	4,9		314	2,5	1,4	330	3400	220
	1,8	17,6	139	2,5	22	178	2,8	33	195	4,2	48	266	5,3	68	340	2,8	1,4	360	3800	220
	2,1		156	2,8		195	3,5		227	4,9		312	5,6		360	2,8	1,4	370	4000	250
	2,8		195	3,5		227	4,2		266	5,6		360	6,3		411	4,2	2,1	370	4900	250
3,5		227	4,2		266	4,9		312	6,3		411	6,6		428	5,3	2,8	360	5800	230	
SUV 2681 Ln XMW 5003 An XMW 4033	0,6		91	0,7		102	1,1		130	2,5		235	3,5		310	1,8	0,7	640	3000	480
	1,1	17,6	130	1,4	22	156	1,8	33	184	3,2	48	285	4,6	68	380	2,5	1,5	640	3800	460
	1,4		156	1,8		184	2,5		235	3,9		330	6,0		475	4,2	1,5	580	4900	430
	1,8		184	2,1		210	2,8		260	4,2		360	6,7		525	4,2	2,0	610	5200	430
SUN 3101 Ln XMW 5004 An XMW 4032	1,0		102	1,8		139	2,5		178	3,2		212	3,9		255	1,0	0,2	250	2700	200
	1,4		116	2,1		156	2,8		195	3,5		227	4,2		275	2,1	0,2	290	3000	220
	1,8		139	2,5		178	3,2		212	3,9		246	4,6		297	2,8	0,4	360	3500	240
	2,1	36	156	2,8	45	195	3,5	68	227	4,2	100	266	4,9	141	314	3,2	1,4	390	3700	280
	2,5		178	3,2		212	4,2		266	4,9		312	5,6		360	3,5	0,7	380	4000	270
	2,8		195	3,5		227	4,9		312	5,6		360	6,3		411	4,2	1,4	390	4800	280
3,5		227	4,2		266	5,6		360	6,3		411	7,0		453	5,6	2,8	380	5900	240	
SUN 3102 Ln XMW 5008 An XMW 4034	1,8		235	1,8		235	2,5		300	3,9		410				1,8	0,2	290	3000	200
	2,1		260	2,1		260	2,8		330	4,2		445				2,8	0,2	300	3400	200
	2,5		300	2,5		300	3,2		355	4,6		480				2,8	0,3	300	4000	200
	2,8	36	330	2,8	45	330	3,5	68	380	4,9	100	529				3,5	0,7	320	4300	220
	3,2		355	3,2		355	3,9		410	5,3		565				3,9	1,5	340	4600	220
	3,5		380	3,5		380	4,2		445	5,6		600				4,2	1,0	330	4700	230
4,2		445	4,2		445	4,9		520	6,3		685				4,9	1,5	340	5500	230	
SUW 3141 Ln XMW 5004 An XMW 4033	0,7		102	1,1		130	1,8		184	3,2		285	5,3		430	2,8	0,7	810	4000	580
	1,1	36	130	1,4	45	156	2,1	68	210	3,5	100	310	6,0	141	475	3,2	1,5	790	4300	580
	1,4		156	2,1		210	2,8		260	4,9		405	6,7		525	5,6	1,5	660	5800	510
	1,8		184	2,5		235	3,2		285	5,9		455	7,0		550	3,9	2,0	840	4300	640
SUN 3175 Ln XMW 5009 An XMW 4034	2,1		260	2,8		330	3,9		410	4,9		520				2,1	0,2	340	3500	240
	2,5		300	3,2		355	4,2		445	5,3		565				3,2	0,2	360	4300	240
	2,8		330	3,5		380	4,6		480	5,6		600				3,9	0,3	360	4900	250
	3,2	64	355	3,9	78	410	4,9	119	520	6,0	175	640				4,9	0,7	360	5500	250
	3,5		380	4,2		445	5,3		565	6,3		685				4,9	1,5	380	5500	250
	4,2		445	4,9		520	5,6		600							5,3	1,0	380	5800	250
4,9		520	5,6		600	6,3		685							5,6	1,5	380	6100	250	
SUN 3280 Ln XMW 5005 An XMW 4034	2,8		330	3,5		380	4,6		480	5,6		600				2,8	0,2	360	4600	250
	3,2		355	3,9		410	4,9		520	6,0		640				3,9	0,2	370	4900	250
	3,5		380	4,2		445	5,3		565	6,3		685				4,6	0,3	370	5200	250
	3,9	102	410	4,6	125	480	5,6	192	600		280					5,3	0,7	380	5500	270
	4,2		445	4,9		520	6,0		640							5,6	1,0	410	5500	270
	4,6		480	5,3		565	6,3		685							5,6	1,5	410	5800	270
4,9		520	5,6		600										6,0	1,5	410	6100	270	



CLASSIC ATOMIZERS

1/2" SIZE

MW

STANDARD BODY



When atomizing higher quantities of liquid is required it is necessary to use larger size atomizer types, as shown in the following pages.

Atomizer design and coding follow the same scheme as smaller size types, with set-up codes and body/option codes. These atomizers offer the same spray patterns as the smaller models, with a capacity range from 32 to 1.158 liter per hour.

The larger size body has two 1/2" inlets, and it is only available in the standard type with no air actuated spray control possible.

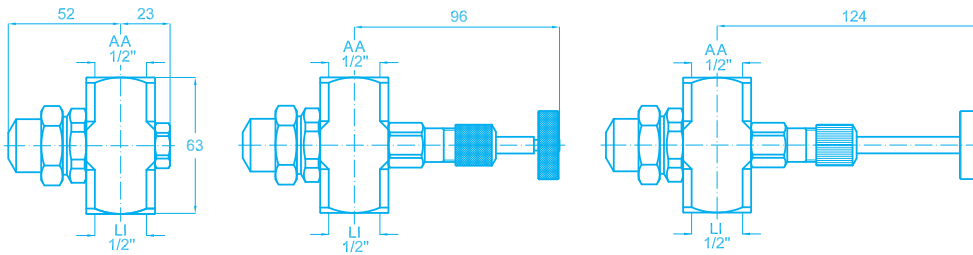
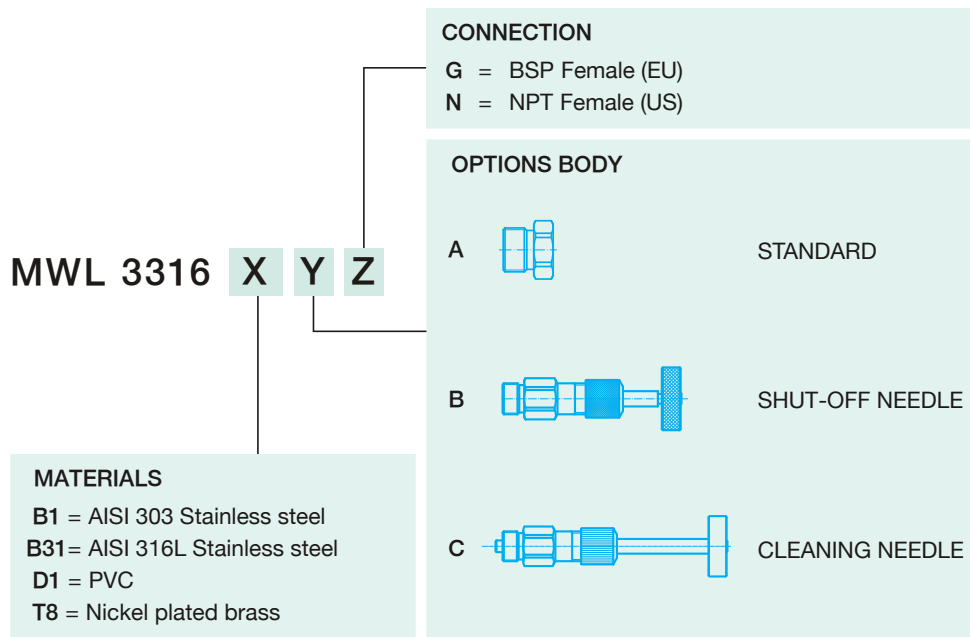

AA = Air Inlet (1/2" F)
LI = Liquid Inlet (1/2" F)

1/2" SIZE

PRESSURE PRINCIPLE

INTERNAL MIX

LARGER CAPACITIES

Larger capacities atomizers shown in these pages work on pressure and siphon liquid feed, and internal and external mix principles. A wide angle hollow cone spray is also available. Approximate jet dimensions are given in the table on the right of the page, while advice about operation adjustment is given at page 8. Please note the larger dimensions for the complete atomizer, as given in the previous page.

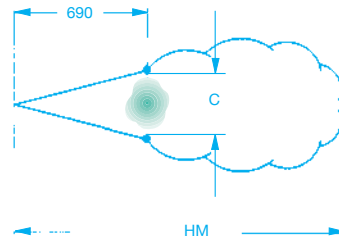

Materials

- B1 AISI 303 Stainless steel
- B31 AISI 316L Stainless steel
- D1 PVC
- T8 Nickel plated brass

WH = Water capacity (l/ora)
AM = Air capacity (NI/min)

Set-up code	Air pressure (bar)																		
	WH	AM	WH	AM	WH	AM	WH	AM	WH	AM	WH	AM	PA	PL	C	HM			
SUL 3316	-	-	-	-	-	-	2,1	213	176	3,1	316	214	4,2	238	351	2,1	2	690	6700
Ln XMW 5201	-	-	-	-	-	-	2,3	127	249	3,2	195	292	4,3	154	439	3,2	3	690	7300
An XMW 4110	-	-	-	-	-	-	-	-	-	3,4	107	371	4,5	100	521	4,2	4	690	8500
SUL 3192	0,6	102	184	1,1	215	153	2,5	185	355	3,7	192	560	5,0	230	830	0,7	0,4	650	6100
	0,7	57	230	1,3	124	230	2,7	146	410	3,9	150	620	5,3	158	940	1,3	1,0	670	7900
	0,9	32	280	1,4	84	280	2,8	112	465	4,0	119	680	5,6	108	1080	2,8	2,0	650	6400
Ln XMW 5201	-	-	-	3,0	86	520	4,2	86	770	-	-	-	-	-	-	4,0	3,0	670	7300
An XMW 4111	-	-	-	3,1	65	580	4,6	51	910	-	-	-	-	-	-	5,3	4,0	690	8200
SUL 3300	0,7	129	325	1,7	182	540	3,1	265	810	4,3	350	1000	-	-	-	0,9	0,4	690	7900
	0,9	82	370	1,8	143	590	3,2	215	860	4,6	260	1080	-	-	-	1,7	1,0	660	7300
	1,0	45	415	-	-	-	3,4	173	910	5,0	186	1200	-	-	-	3,4	2,0	660	7000
Ln XMW 5201	-	-	-	3,5	136	950	-	-	-	-	-	-	-	-	-	4,6	3,0	690	8500
An XMW 4112	-	-	-	3,6	120	980	-	-	-	-	-	-	-	-	-	-	-	-	-
SUM 3740	0,7	134	315	1,3	320	440	2,1	575	570	3,0	740	710	3,9	840	860	0,7	0,4	910	3400
	0,9	100	380	1,4	255	520	2,2	505	640	3,1	690	770	4,1	790	930	1,4	1,0	910	4900
	-	-	-	1,5	200	590	2,4	440	720	3,2	630	840	4,2	740	990	2,5	2,0	810	6100
	-	-	-	1,7	154	670	2,5	380	790	3,4	570	910	4,4	690	1070	3,4	3,0	740	6700
	-	-	-	-	-	-	2,7	330	860	3,5	520	980	4,5	650	1140	4,5	4,0	730	7600
	-	-	-	-	-	-	2,8	275	930	3,7	470	1050	4,6	600	1210	-	-	-	-
	-	-	-	-	-	-	3,0	235	1010	3,8	420	1120	4,8	550	1280	-	-	-	-
	-	-	-	-	-	-	3,1	195	1080	3,9	345	1190	4,9	510	1350	-	-	-	-
	-	-	-	-	-	-	-	-	-	4,1	325	1260	5,1	465	1430	-	-	-	-
	-	-	-	-	-	-	-	-	-	-	-	-	5,2	425	1490	-	-	-	-
Ln XMW 5202	-	-	-	-	-	-	-	-	-	-	-	-	5,3	390	1560	-	-	-	-
An XMW 4113	-	-	-	-	-	-	-	-	-	-	-	-	5,5	350	1640	-	-	-	-
SUB 3230	1,3	34	350	1,7	146	365	3,0	230	510	-	-	-	-	-	-	1,4	0,4	-	6700
	1,4	25	390	1,8	121	395	3,1	200	550	-	-	-	-	-	-	2,0	1,0	250	7300
	1,5	20	415	2,0	102	430	3,2	176	590	-	-	-	-	-	-	3,2	2,0	-	8200
	1,7	15,5	445	2,1	86	460	3,4	154	620	-	-	-	-	-	-	-	-	-	-
Ln XMW 5201	-	-	-	2,3	72	490	3,5	135	660	-	-	-	-	-	-	-	-	-	-
An XMW 4101	-	-	-	2,4	60	520	3,6	118	700	-	-	-	-	-	-	-	-	-	-
SUB 3740	0,7	134	315	1,3	320	440	2,1	575	570	3,0	740	710	3,9	840	860	0,7	0,4	230	7000
	0,9	100	380	1,4	255	520	2,2	505	640	3,1	690	770	4,1	790	930	1,4	1,0	280	6400
	-	-	-	1,5	200	590	2,4	440	720	3,2	630	840	4,2	740	990	2,5	2,0	250	11300
	-	-	-	1,7	154	670	2,5	380	790	3,4	570	910	4,4	690	1070	3,4	3,0	250	12500
	-	-	-	-	-	-	2,7	330	860	3,5	520	980	4,5	650	1140	4,5	4,0	250	14300
	-	-	-	-	-	-	2,8	275	930	3,7	470	1050	4,6	600	1210	-	-	-	-
	-	-	-	-	-	-	3,0	235	1010	3,8	420	1120	4,8	550	1280	-	-	-	-
	-	-	-	-	-	-	3,1	195	1080	3,9	345	1190	4,9	510	1350	-	-	-	-
	-	-	-	-	-	-	-	-	-	4,1	325	1260	5,1	465	1430	-	-	-	-
	-	-	-	-	-	-	-	-	-	-	-	-	5,2	425	1490	-	-	-	-
Ln XMW 5202	-	-	-	-	-	-	-	-	-	-	-	-	5,3	390	1560	-	-	-	-
An XMW 4102	-	-	-	-	-	-	-	-	-	-	-	-	5,5	350	1640	-	-	-	-
SUM 3184	-	-	-	1,8	154	590	3,4	184	950	-	-	-	-	-	-	2,0	1,0	910	5800
	-	-	-	2,0	119	640	3,5	157	1010	-	-	-	-	-	-	3,5	2,0	970	7000
	-	-	-	2,1	93	690	3,7	133	1060	-	-	-	-	-	-	-	-	-	-
Ln XMW 5201	-	-	-	-	-	-	3,8	112	1110	-	-	-	-	-	-	-	-	-	-
An XMW 4120	-	-	-	-	-	-	-	-	-	-	-	-	-	-	-	-	-	-	-
SUQ 3740	0,7	134	315	1,3	320	440	2,1	575	570	3,0	740	710	3,9	840	860	0,7	0,4	1190	4000
	0,9	100	380	1,4	255	520	2,2	505	640	3,1	690	770	4,1	790	930	1,4	1,0	2110	4600
	-	-	-	1,5	200	590	2,4	440	720	3,2	630	840	4,2	740	990	2,5	2,0	2080	5200
	-	-	-	1,7	154	670	2,5	380	790	3,4	570	910	4,4	690	1070	3,4	3,0	2160	5800
	-	-	-	-	-	-	2,7	330	860	3,5	520	980	4,5	650	1140	4,5	4,0	2260	6400
	-	-	-	-	-	-	2,8	275	930	3,7	470	1050	4,6	600	1210	-	-	-	-
	-	-	-	-	-	-	3,0	235	1010	3,8	420	1120	4,8	550	1280	-	-	-	-
	-	-	-	-	-	-	3,1	195	1080	3,9	345	1190	4,9	510	1350	-	-	-	-
	-	-	-	-	-	-	-	-	-	4,1	325	1260	5,1	465	1430	-	-	-	-
	-	-	-	-	-	-	-	-	-	-	-	-	5,2	425	1490	-	-	-	-
Ln XMW 5202	-	-	-	-	-	-	-	-	-	-	-	-	5,3	390	1560	-	-	-	-
An XMW 4121	-	-	-	-	-	-	-	-	-	-	-	-	5,5	350	1640	-	-	-	-

WIDE ANGLE ROUND SPRAY

ROUND SPRAY

FLAT FAN SPRAY

0,35

1,0

2,0

3,0

4,0

Liquid pressure (bar)

MORE SET-UP TYPES

1/2" SIZE

LARGER CAPACITIES

EXTERNAL MIX / FLAT JET

These set-ups can atomize high viscosity liquids and use the wide regulation range possible with independent regulation of the air and liquid pressure. See previous page for materials

Set-up code	Air pressure (bar)																			
	WH		AM		WH		AM		WH		AM		WH		AM		PA	PL	C	HM
SUM 4145 Ln XMW 5201 An XMW 4135	2,1		877	2,8		1075	3,2		1174	3,9		1358	5,6		1839	2,5	0,2	520	5800	
	2,4		962	3,2		1174	3,5		1273	4,2		1457	6,0		1952	3,5	0,4	550	6700	
	2,8	522	1075	3,5	681	1273	3,9	795	1358	4,9	953	1641	6,3	1158	2037	3,9	0,5	580	7020	
	3,2		1174	3,9		1358	4,2		1457	5,3		1754	6,6		2122	4,9	0,7	610	7630	
				4,2		1457	4,6		1556	5,6		1839	7,0		2207	6,3	1,0	660	8850	
	0,2		0,35		0,5		0,7		1											
Liquid pressure (bar)																				

INTERNAL MIX / HOLLOW CONE JET

This set-up produces a wide angle hollow cone jet, which can be useful in such cases where a coating must be applied inside a pipe or duct. See previous page for materials.

Set-up code	Air pressure (bar)																			
	WH		AM		WH		AM		WH		AM		WH		AM		PA	PL	C	HM
SUZ 3460 Ln XMW 5202 An XMW 4146	1,0	213,0	345	1,7	394	453	2,5	439	634	3,4	462	787	5,0	484	1138					
	1,1	145,0	418	1,8	324	526	2,7	372	702	3,5	416	843	5,2	439	1197					
	1,3	97,6	575	2,0	275	574	2,8	322	750	3,7	372	891	5,3	409	1254					
	1,4	59,0	538	2,1	207	642	3,0	277	818	3,8	325	956	5,5	366	1310					
	-	-	-	2,3	159	702	3,1	272	874	3,9	282	1019	5,6	325	1367					
	-	-	-	2,4	116	758	3,2	188	931	4,1	250	1084	5,8	297	1429					
	-	-	-	2,5	93	829	3,4	145	990	4,2	209	1135	5,9	257	1486					
	-	-	-	2,7	27	900	3,5	114	1050	4,4	168	1189	6,0	232	1551					
	-	-	-	-	-	-	-	-	-	4,5	141	1259	6,3	182	1670					
	-	-	-	-	-	-	-	-	-	4,6	77	1296	-	-	-					
		0,7		1,4		2,1		2,8		4,2										
Liquid pressure (bar)																				

SIPHON PRINCIPLE / INTERNAL MIX / FULL CONE JET

This set-up offers the same performances as the set-ups shown at page 15, with a larger capacity. See previous page for materials

Set-up code	Air pressure (bar)																		
	Air capacity (Nml/min)																		
	Liquid capacity (lph)										PA	HM							
SUC 2230 Ln XMW 5201 An XMW 4145	0,7	360	-	-	-	40	-	-	-	-	-	-	-	-	-	1,5	6100		
	1,5	570	-	-	-	97	64,0	-	-	-	-	-	-	-	-	2,0	6700		
	2,0	660	-	-	-	117	90,0	-	-	-	-	-	-	-	-	3,0	7300		
	3,0	870	-	260,0	225	150	123,0	90	-	-	-	-	-	-	-	3,5	7900		
	3,5	990	300	265,0	235	163	133,0	104	-	-	-	-	-	-	-	4,0	8800		
	4,0	1100	305	270,0	240	170	143,0	115	-	-	-	-	-	-	-	5,0	9800		
	5,0	1300	315	280,0	250	183	157,0	129	53	-	-	-	-	-	-	5,6	10700		
	5,6	1450	320	290,0	255	188	164,0	136	62	-	-	-	-	-	-	-	-	-	
	450		300		150		100		200		300		600						
Gravity head (mm)										Suction head (mm)									

OPTIONS AND ACCESSORIES

SINGLE AIR INLET (Body option U)

Air actuated atomizers can be supplied with a single air inlet for both the atomizing process and the air cylinder, which allows to operate a line of atomizers with only one air line and avoids air waste during the dead cycle times when atomizing is stopped.

With this layout the liquid inside the set-up, at shut-off time, will be atomized with a low air/liquid ratio and large drops may be produced: this option may be used for long dead times in atomizing cycles when some large droplet may be tolerated and it is necessary to limit system investment cost.

Minimum working pressure 2 bar.



AUTOMATIC WITH LOCKING-NEEDLE SCREW

MX series atomizers can be automatic with a locking-needle screw. The utility consists in being able to manually close the needle, blocking the operation independently from the pressure of the driving air. This option is used to temporarily block one or more atomizers of a line without disturbing the working of the others.



SPECIAL MATERIALS AND COATINGS

Our engineering office is available to design, test and produce bodies, set-ups and complete systems according to the customer requirements.

Special parts, bodies and systems which suit specific customer needs can be arranged under confidentiality agreements, supplied exclusively and not advertised.

SPECIAL DESIGN

Our engineering office is available to design, test and produce bodies, set-ups and complete systems according to the customer requirements. Special parts, bodies and systems which suit specific customer needs can be arranged under confidentiality agreements, supplied exclusively and not advertised.



XMW 1021 xx

ATOMIZER WALL MOUNTING

It is often convenient to mount atomizers through the wall of a tank or a duct for air treatment, keeping the atomizers and the feed lines on the outside for ease of maintenance. The following parts can serve this purpose for both MW standard atomizers and MX air actuated ones.



WALLS THICKER THAN 10 MM

A nipple XMW 0021 xx with an outer tapered thread 3/4" BSPT is recommended, with a corresponding passage in the wall threaded 3/4" straight thread.

WALLS THINNER THAN 10 MM

For thin walls it is recommended to use a XMW 0020 xx nipple with a 3/4" straight thread, secured through the locknut VAC 0076 xx and the VDA 26A1 P7 seal. The above three parts can be ordered together with the assembly code XMW 0025 xx. A simple hole with 27 mm diameter is required into the wall.

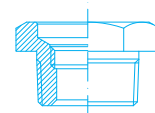

XMW 0021 xx

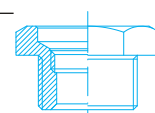

XMW 0020 xx



VDA 26A1 P7



VAC 0076 xx



Materials	Nipple, Locknut	B1 AISI 303 stainless steel T8 Nickel plated brass
	Seal	P7 Oil proof seal material

XMW 0025 xx

OPTIONS AND ACCESSORIES

UMR

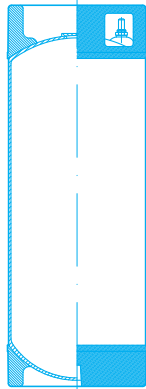

PRESSURE TANKS

These tanks make it possible to produce atomized sprays in places where a liquid supply under pressure is not available.

These tanks, once filled with the required liquid quantity, are put under pressure with the aid of compressed air and are then ready to serve as a source of liquid under pressure.

Completely built out of high quality stainless steel, UMR tanks have the upper and bottom part protected by a rubber lining and are supplied complete of an air tight cover, pressure safety valve and, if required, quick connection nipples.

The product codes in the following table are given for tanks with cover only, and for tanks with cover and connection nipples.

The maximum operation pressure is given for each type, according to PED norms, from a self-sticking label, see LP value in the table.

Materials

Body	B2	AISI 304 Stainless steel
Base & Handles	E8	Synthetic rubber (NBR)
Quick connection	E31	DELRIN®
O-Ring	E0	EPDM

Code Cover only	Cover and nipples	CA liters	D mm	H mm	W kg	LP bar
UMR 0090 B2	UMR C090 B2	9	232	340	3,7	4,9
UMR 0190 B2	UMR C190 B2	18	219	630	4,3	4,9

When a source of liquid under pressure is available, as in the case of a UMR tank, several applications become possible as for example the atomizing cart shown in the picture beside. These carts are designed on specific requirements and are usually fitted with regulation valves to obtain the desired spray characteristics and electronic control. Often used to disinfect single rooms in hospitals, the cart can be programmed to spray for a given time, and to start spraying with a delay which allows the personnel to leave the room before spraying starts.

The components in the following list can be ordered as single spare parts by means of their product code. Please note that both connection kit, air and liquid, can only be supplied as a complete assembly, it is not possible to supply single components.

XUM R040 B2	Cover complete
XUM R100 E31	Air connection kit
XUM R110 E31	Liquid connection kit



SPECIAL ATOMIZERS

In many industries, such as in metals industry or chemical industry, bi-phase water-air atomizers are mainly, but not only, used to suppress and cool fumes. In these situations, it is very important to have products that give a homogenous distribution of the nebulized jet that interact with the gaseous phase, and to have the possibility to work with a wide range of pressures, both for water and air.

PNR Italia 50-years' experience allows to find different solutions for the difficult problems the company has faced for its clients, and in this page you can find some special atomizers that have been created, with a special attention to their industrial applications.

In this page, we present, for information only, the products currently available. For more detailed information on the performance and size of individual products, we invite you to visit our website www.pnr.eu in the "Special Atomizers" section (link: www.pnr.eu/it/prodotti/atomizzatori-speciali/), or write an email to info@pnr.it.

MF

In many industrial processes requiring gas cooling, fumes suppression or the injection of chemicals, it is necessary to use suitable air atomizing nozzles. PNR bi-phase nozzles MF series are products specifically designed to improve the efficiency of the manufacturing processes with a reduced energy consumption and a low clogging risk. The special geometry of the MF air atomizing nozzles provides a uniform spray pattern and small droplets.

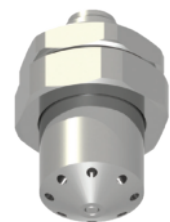

MN, MO

The MN series atomizers are normally used to cool blooms and billets. They have a full cone spray pattern and a mounting system to the support plates through two pins and O-rings in Viton. They can be supplied with 1/4" or 3/8" female liquid/air connections upon request. All MN atomizers are supplied with a capacity/pressure chart so to be able to adjust the pumps to the capacities required by the plant.

The MO atomizers with oval spray coverage are normally used to cool blooms and billets. They have a fastening system to lock them on the supporting plates through two pins and O-ring in Viton. On request they can be supplied with 1/4" or 3/8" female liquid/air connections upon request. All MO atomizers are supplied with a capacity/pressure chart in order to adjust the pumps to the capacities required for the plant.



MB, MT

In continuous casting, and in slab casting in particular, lance atomizers replace conventional compact atomizers, currently called block atomizers, where the atomizer body is equipped with an extension and the spray tip is located at the exit end of the extension. The reasons of this replacement are due either to the geometrical need to insert the spraying pipe between rolls, whose clearance is often very small and prevents the use of block atomizers, or to the convenience to position the feeding pipes far from the intensely heated area near the slabs.

Lance atomizers can be classified according to different parameters:

Atomizer's body: the body where atomization is generated is matched by a plug-in connection to fluid feeding ducts, may have different shapes according to the model and may be casted or machined.

Geometry of the pipe: straight pipe, or bent type.

Connections of the pipe to the body: the extension pipe is welded onto the block body, or the extension pipe is screwed to the block body with a locknut.

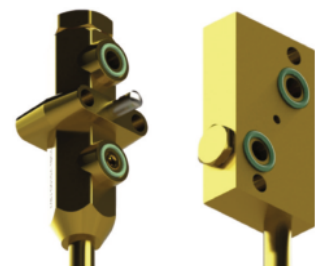

HYDRAULIC ATOMIZERS

RX - RW - RZ



HYDRAULIC ATOMIZERS

RX and RZ hollow cone nozzle delivers a very finely atomized hollow cone spray, even at low pressure values. They contain a precisely machined insert with narrow passages that can be easily disassembled for cleaning in case of obstruction. Clogging can be avoided placing a fine mesh strainer on the main manifold or using an individual filter.

RW atomizers works in the same way, but the nozzle is mounted on the pipe by means of a welded nipple ZAA and a locknut VAA.

Thread specification:

BSPT, NPT, nipple and locknut

Typical applications:

dust control, humidification, deodorant spray, disinfectant liquid spray, exhaust scrubbers

Suggested filters:

We suggest to use a threaded filter VEF to protect the nozzle against clogging. You can choose between 50, 75 or 100 mesh.

Code	D mm	Capacity at different pressure values										l/hour bar
		1.5	2.0	3.0	4.0	5.0	6.0	10	15	20	50	
80°	RXT 0060 xx	0.50		2.94	3.60	4.16	4.65	5.09	6.57	8.05	9.30	14.7
	RXT 0100 xx	0.50		4.90	6.00	6.93	7.75	8.49	11.0	13.4	15.5	24.5
	RXT 0130 xx	0.70	5.52	6.37	7.80	9.01	10.1	11.0	14.2	17.4	20.1	31.8
	RXT 0190 xx	0.70	8.06	9.31	11.4	13.2	14.7	16.1	20.8	25.5	29.4	46.5
	RXT 0250 xx	1.00	10.6	12.2	15.0	17.3	19.4	21.2	27.4	33.5	38.7	61.2
	RXT 0380 xx	1.00	16.1	18.6	22.8	26.3	29.4	32.2	41.6	51.0	58.9	93.1
	RXT 0510 xx	1.50	21.6	25.0	30.6	35.3	39.5	43.3	55.9	68.4	79.0	125
	RXT 0650 xx	1.60	27.6	31.8	39.0	45.0	50.3	55.2	71.2	87.2	101	159
	RXT 0780 xx	1.90	33.1	38.2	46.8	54.0	60.4	66.2	85.4	105	121	191
	RXT 0910 xx	1.90	38.6	44.6	54.6	63.0	70.5	77.2	99.7	122	141	223
	RXT 1116 xx	1.90	49.2	56.8	69.6	80.4	89.9	98.4	127	156	180	284
	RXT 1143 xx	1.90	60.7	70.1	85.8	99.1	111	121	157	192	222	350
	RXT 1166 xx	2.20	70.4	81.3	99.6	115	129	141	182	223	257	407

Code	D mm	Capacity at different pressure values										l/min bar
		1.5	2.0	3.0	4.0	5.0	6.0	10	15	20	50	
60°	RZQ 0080 xx	0.45		0.07	0.08	0.09	0.10	0.11	0.15	0.18	0.21	0.33
	RZQ 0120 xx	0.55		0.10	0.12	0.14	0.15	0.17	0.22	0.27	0.31	0.49
	RZQ 0250 xx	0.80	0.18	0.20	0.25	0.29	0.32	0.35	0.46	0.56	0.65	1.02
	RZQ 0390 xx	1.00	0.28	0.32	0.39	0.45	0.50	0.55	0.71	0.87	1.01	1.59
	RZQ 0560 xx	1.20	0.40	0.46	0.56	0.65	0.72	0.79	1.02	1.25	1.45	2.29
	RZQ 0780 xx	1.40	0.55	0.64	0.78	0.90	1.01	1.10	1.42	1.74	2.01	3.18
	RZQ 1100 xx	1.60	0.71	0.82	1.00	1.15	1.29	1.41	1.83	2.24	2.58	4.08
	RZQ 1140 xx	1.90	0.99	1.14	1.40	1.62	1.81	1.98	2.56	3.13	3.61	5.72
	RZQ 1170 xx	2.10	1.20	1.39	1.70	1.96	2.19	2.40	3.10	3.80	4.39	6.94
	RZQ 1200 xx	2.30	1.41	1.63	2.00	2.31	2.58	2.83	3.65	4.47	5.16	8.16

RW capacities are the same as RX nozzle. To have the complete product code, you just have to change "RX" with "RW".

The last two letters ("xx") indicate the material, and must be changed with one of the following:

B1 = AISI 303 Stainless steel

B31 = AISI 316L Stainless steel

T1 = Brass

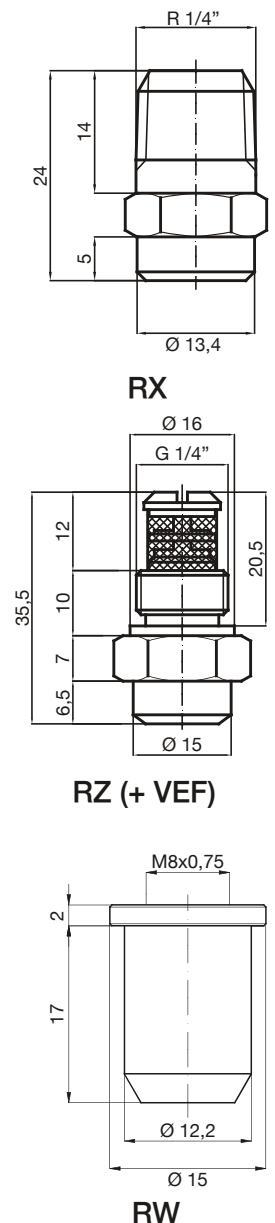

GENERAL INFORMATION

ABBREVIATION LIST

AH	Air capacity	Ncm/hour	CA	Internal volume	liters	LP	Max operation pressure	bar
AM	Air capacity	NI/min	CH	Wrench size	mm	PA	Air pressure	bar
AA	Atomizing air inlet	inch	HM	Maximum spray throw	mm	PL	Liquid pressure	bar
AC	Cylinder air inlet	inch	HR	Length of coherent spray	mm	WH	Water capacity	l/hour
An	Air nozzle code	---	LI	Liquid inlet size	inch	WM	Water capacity	l/min
C	Spray width	mm	Ln	Liquid nozzle code	---			

PRODUCT WARRANTY

PNR products will be replaced or repaired at the option of PNR and free of charges if found defective in manufacturing, labelling and packaging. The above conditions will apply if notice of defects is received by PNR within 30 days from date of product installations or one year from date of shipment.

The cost of above said replacement or repair shall be the exclusive remedy for any breach of any warranty, and PNR shall not be held liable for any damage due to personal injuries or commercial losses coming from product malfunction. It is self-understood that no warranty may apply in case our products have been operated under nonacceptable conditions, like for example (but not limited to):

- Operation at pressures exceeding those shown in catalogue performance table
- Operation with or exposure to liquids containing abrasive particles
- Operation with or exposure to liquids producing a chemical attack on the nozzle material
- Mechanical damages to nozzle orifices, nozzle spray edge or body due to careless handling or assembling.

In all above cases, the customer must accept a nozzle life reduction below life expected, or performance parameters below the values in the catalogue. The guarantee may be exercised as follows:

- By sending a precautionary report to PNR on the detected damages. This report can also be sent by email to this address: quality@pnr.it
- If PNR ascertains that the manufacturing faults are actually subject to the warranty, the product shall have be returned to the manufacturer in its original packaging prior request of authorization to the manufacturer and receipt of manufacturer's written authorization.
- The rejected goods shall have be returned by the means that PNR will communicate to the customer and the transportation costs of returned merchandise will be entirely borne by the manufacturer.

Our products are manufactured with the best care and according to the latest developments of the technology available. However we cannot assure that every one of our products is perfectly fit for every specific application. The information in this catalogue is provided "as seen" and so we offer no warranty of any kind with respect to the subject matter or accuracy of the information contained herein. This publication may include technical inaccuracies or typographical errors and changes may be periodically made to the information herein without prior notice.

A GLOBAL PRESENCE ALL OVER THE WORLD.

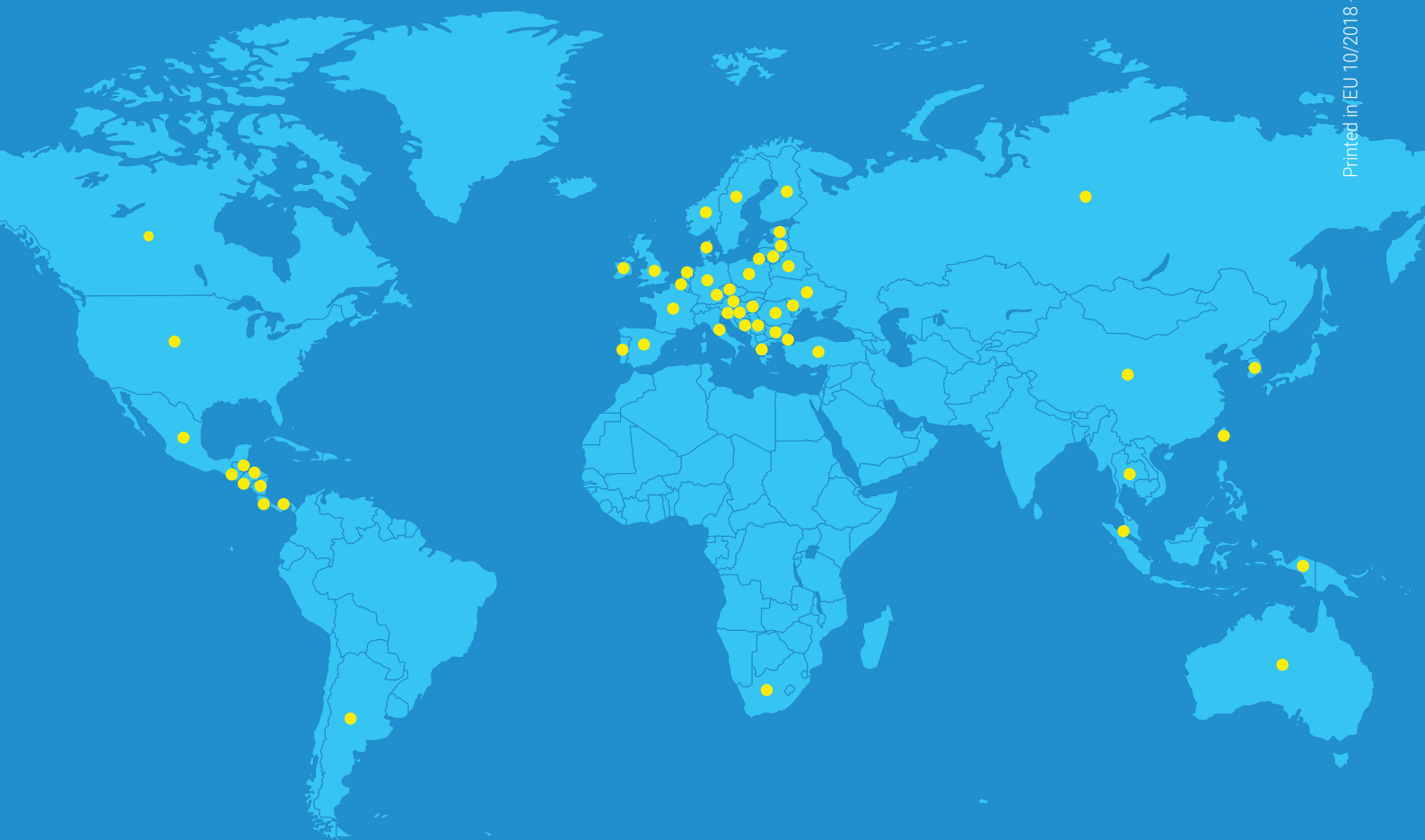

Printed in EU 10/2018 - CTGAT EN - ©PNR Italia, all rights reserved



HEADQUARTERS:

PNR Italia srl Via Nenni/Gandini 27058 Voghera (PV) Italia

Phone +39 0383 344 611 Fax +39 0383 212 489

Email info@pnr.it For more info, visit www.pnr.eu

